



Automotive Lamps

Catalogue Lampes Auto

Lichtprogramm Fahrzeuglampen

Catalogo Lampade Automotive

Catálogo Lámparas de Automoción



 **Tungstram**, one of Europe's most iconic lighting brands, has entered an exciting new phase in its history with the acquisition of GE Lighting's Europe, Middle East, Africa and Turkey lighting operations along with the Global Automotive business. The heritage of Tungstram, as well as GE Lighting's, is that of innovation. Only the name has changed, but not the principle: finding new opportunities for innovation in product and service. Tungstram continues existing design, production and R&D operations, making use of computer-managed and controlled processes, fully automated production lines, and certified quality assurance systems.

Tungstram continues to offer a wide range of vehicle lamps - operating on either 12V or 24V systems - both for OEM and aftermarket use. All automotive products currently are marketed as GE and Tungstram, but GE brand name will become Tungstram products. This catalogue contains GE product codes - upon request a separate Tungstram catalogue is available for Tungstram branded products.

 **Tungstram**, eine große und bekannte europäische Marke im Bereich Beleuchtung, schlägt ein neues Kapitel seiner Geschichte auf. Mit dem Kauf des Beleuchtungsgeschäfts von GE Lighting in Europa, im Nahen Osten, in Afrika und in der Türkei sowie des globalen Geschäftszweiges Automotive Lighting, ändert sich zwar der Name, nicht aber das Grundprinzip: Das finden neuer Innovationen bei Produkten und Dienstleistungen.

Tungstram führt das bisherige Design, Produktion, Forschung und Entwicklung fort und verwendet computergestützte und kontrollierte Prozesse, vollautomatisierte Produktionslinien sowie ein zertifiziertes Qualitätssicherungssystem.

Tungstram wird auch weiterhin eine große Bandbreite von 12 Volt und 24 Volt Autolampen für den OEM- und Aftermarket anbieten. Alle Produkte für den Automobilbereich werden zur Zeit unter den beiden Marken GE und Tungstram verkauft. Der Markenname GE soll nach einer gewissen Zeit vollständig in die Marke Tungstram übergehen.

Dieser Katalog enthält GE Artikelnummern. Auf Anfrage ist ein Katalog mit Tungstram Artikelnummern erhältlich.

 **Tungstram**, uno dei marchi di illuminazione più iconici d'Europa, è entrato in una nuova entusiasmante fase della sua storia con l'acquisizione di GE Lighting Europa, Medio Oriente, Africa e Turchia insieme al business Global Automotive.

Solo il nome è cambiato, ma non la missione: trovare nuove opportunità di innovazione nei prodotti e nei servizi.

Tungstram prosegue le attività di progettazione, produzione e ricerca e sviluppo esistenti, avvalendosi di processi computerizzati, linee di produzione completamente automatizzate con la garanzia dei sistemi di qualità certificata.

Tungstram continua a offrire una vasta gamma di lampade per veicoli, operanti a 12V e 24V, sia per OEM che ricambi.

Tutti i prodotti automotive sono attualmente commercializzati con il brand GE e Tungstram, ma il marchio GE cambierà in Tungstram nel prossimo periodo.

Questo catalogo contiene i codici prodotto GE. Su richiesta è disponibile il catalogo separato per i prodotti a solo marchio Tungstram.

 **Tungstram**, l'une des marques d'éclairage les plus emblématiques d'Europe, est entrée dans une nouvelle phase passionnante de son histoire par l'acquisition de la ligne d'activité d'éclairage de GE Lighting en Europe, au Moyen-Orient, en Afrique et en Turquie ainsi que de la ligne d'activité globale de la division Lampes Auto.

Seul le nom a changé, les principes restent les mêmes : trouver de nouvelles opportunités d'innovation tant au niveau des produits qu'au niveau des services.

Tungstram poursuit ses activités actuelles de conception, de production et de recherche et développement, en exploitant le potentiel des processus contrôlés et gérés par ordinateur, des chaînes de production entièrement automatisées et des systèmes d'assurance qualité certifiés.

Tungstram continue à offrir une large gamme de lampes de véhicules, utilisées à une tension de fonctionnement de 12V ou de 24V, pour les clients OEM et après-vente.

Tous les produits automobiles sont actuellement commercialisés sous les noms de GE et Tungstram, mais la marque GE sera progressivement remplacée par Tungstram.

Ce catalogue contient des codes de produits GE. À la demande, nous mettons à votre disposition le catalogue Tungstram qui comprend uniquement des produits de la marque Tungstram.

 **Tungstram**, una de las marcas de iluminación más emblemáticas de Europa, ha entrado en una nueva y emocionante etapa de su historia con la adquisición de los negocios de iluminación de GE Lighting en Europa, Medio Oriente, África y Turquía, así como también el de lámparas de Automoción a nivel Global. Solo el nombre ha cambiado, pero no la base: continuar su desarrollo e innovación para encontrar nuevas oportunidades en productos y servicios.

Tungstram continuará con las actuales operaciones existentes de diseño, producción e I+D, haciendo uso de los procesos más modernos controlados por ordenador, líneas de producción totalmente automatizadas y sistemas de garantía de calidad debidamente certificados.

Tungstram continuará ofreciendo una amplia gama de lámparas para vehículos en 12V y 24V para el mercado OEM (primer equipo) así como para AM (mercado del recambio).

Actualmente todas las lámparas de auto se comercializan con las marcas GE y Tungstram. En un período de transición, aún por determinar, la marca GE pasará a convertirse en marca Tungstram también.

Este catálogo contiene códigos de productos en marca GE. En caso sea de su interés, disponemos de un catálogo con estos mismos productos en marca Tungstram.



Certification



 The company is on the Approval list of many of the worlds car manufacturers, where quality and performance are key measurements. The reliability and quality of automotive lamps is ensured by:

- Computer-managed and controlled design process
- Fully automated production lines
- High level of quality assurance system
- Continued investment programs
- A commitment to continuous improvement

 Nos lampes figurent dans les références en homologation de beaucoup de constructeurs dans le monde qui est une reconnaissance de leur qualité et de leur performance. La fiabilité et la qualité sont assurées

- par un procédé de fabrication assisté et contrôlé par ordinateur
- par des lignes de fabrication automatiques
- et par un système de qualité de haut niveau

 Unser Unternehmen befindet sich auf den meisten Freigabelisten der weltweiten Automobilindustrie, dort wird der Schwerpunkt auf Qualität und Leistungsfähigkeit gesetzt. Die verlässliche Qualität der Automobillampen wird erreicht durch

- computergestützte 100% Qualitätskontrolle
- vollautomatische Produktionsverfahren
- hochentwickelte Qualitätssicherungssysteme

 Nuestra compañía está Homologada en la mayoría de fabricantes de automóviles en el ámbito mundial, lo que significa que las medidas de calidad son claves. La fiabilidad en la calidad de nuestras lámparas de automoción está garantizada por:

- Control total del diseño de proceso por ordenador.
- Líneas de producción totalmente automáticas.
- Los más estrictos controles de calidad.

 L'azienda ed i suoi prodotti sono omologati dai principali costruttori di automobili di tutto il mondo per i quali la qualità e le prestazioni sono parametri fondamentali. L'affidabilità e qualità delle nostre lampade auto sono garantite da:

- Controllo gestione computerizzata totale del processo di sviluppo del prodotto
- linee di produzione completamente automatizzate
- elevato livello di sistema di garanzia della qualità.



ISO 9001, IATF 16949



ECE compliance, homologation



Global OEM customer base

EoLV, ROHS compliance



Use of UV cut glass, safe for use in plastic headlights

Contents

Introduction, Certification, Contents, Automotive Lamps Introduction - Einführung - Introducción - Introduzione	2-7
"XENSATION™" - D1S, D1R, D2S, D2R, D3S, D3R, D4S, D4R headlight lamps 12V Lampes principales D1S, D1R, D2S, D2R, D3S, D3R, D4S, D4R – 12V SAE-Hauptscheinwerferlampen D1S, D1R, D2S, D2R, D3S, D3R, D4S, D4R – 12V Lámparas de faro D1S, D1R, D2S, D2R, D3S, D3R, D4S, D4R "XENSATION™"	8-9
12V halogen headlight lamps - "PREMIUM" 12V Lampes principales halogene - Halogen Scheinwerferlampen - Lámparas de faro halógenas - Lampade per proiettori alogene "PREMIUM"	10-11
MEGALIGHT ULTRA +150	12-13
MEGALIGHT ULTRA +130	14-15
MEGALIGHT ULTRA +120	16-17
MEGALIGHT ULTRA +90	18
MEGALIGHT PLUS	19
SPORTLIGHT - incl. miniature lamps	20-21
SPORTLIGHT ULTRA	22
SPORTLIGHT EXTREME	23
EXTRA LIFE - incl. miniature lamps	24-25
RALLY - OFF ROAD	26
LED - DRL, miniature	27
MOTORCYCLE	28-29
12V Headlight lamps - R2, H4 - upper and lower beam, H1, H2, H3, H7, H8, H9, H10, H11, HB3, HB4 - single filament lamps 12V Lampes principales H4, R2, Lampes monofilament H1, H2, H3, H7, H8, H9, H10, H11, HB3, HB4 – 12V Zweifaden-Hauptscheinwerferlampen H4, R2, Einfadenlampen H1, H2, H3, H7, H8, H9, H10, H11, HB3, HB4 – 12V Lámparas de faro H4, R2 de doble filamento, Lámparas de un filamento H1, H2, H3, H7, H8, H9, H10, H11, HB3, HB4 – 12V Lampade per proiettori H4, R2, Lampade ad un filamento H1, H2, H3, H7, H8, H9, H10, H11, HB3, HB4	30-31
Miniature lamps - "PREMIUM" Lampes miniatures - Miniaturlampen - Lámparas miniatura - lampade miniature "PREMIUM"	32-33
12V Tail, stop and direction lamps 12V Feu rouge/Stop/Clignotant – 12V Blink-, Brems- und Schlußlichtlampen – 12V Lámparas traseras, freno e intermitente 12V Lampade per fanali posteriori, luci di arresto e direzione	34
12V Interior lamps, miniature halogen lamps 12V Lampes éclairage intérieur, lampes miniatures halogene – 12V Lampen für Innenbeleuchtung, miniatur-halogenlampen – 12V Lámparas de interior, lámparas halógenas miniatura – 12V Lampade per illuminazione interna, lampade miniature alogene	35
12V Tail, direction, parking and indicator lamps 12V Feu rouge/clignotant/Feu de position/Répetiteur latéral - 12V Blink-, Brems- und Schlußlichtlampen - 12V Lámparas traseras, marcha atrás e indicadoras - 12V Lampade per fanali posteriori, luci di arresto e direzione	36
12V Wedge base lamps with and without plastic cap 12V Lampes "wedge base" avec ou sans culot plastique - 12V Glassockellampen mit und ohne Steckfassung - 12V Lámparas con casquillo de vidrio y lámparas con base de plástico - 12V Lampade con attacco vetro e/o in plastica	37
"Heavy Star" - Heavy Duty Long Life - 24V Truck lamps with longer life and increased robustness Les lampes 24V pour les poids lourds avec une durée de vie allongée et une résistance accrue - Lampade per Camion : 24V, durata di vita e robustezza superiori alle lampade standard - Lámparas de camión de 24V, con una duración de vida más larga y una mayor solidez - 24V Lampen für LKW und Busse mit längerer Lebensdauer und höherer Robustheit	38-39
24V Headlight lamps – upper and lower beam 24V Lampes principales – 24V Hauptscheinwerferlampen – 24V Lámparas de faro – 24V Lampade per proiettori – abbagliante ed anabbagliante	40
24V Tail, direction, parking and indicator lamps 24V Feu rouge/clignotant/Feu de position/Répetiteur latéral - 24V Blink-, Brems- und Schlußlichtlampen - 24V Lámparas traseras, marcha atrás e indicadoras - 24V Lampade per fanali posteriori, luci di arresto e direzione	41-42
24V Interior lamps 24V Lampes éclairage intérieur – 24V Lampen für Innenbeleuchtung – 24V Lámparas de interior – 24V Lampade per illuminazione interna	43
24V Tail, stop and direction lamps 24V Feu rouge/Stop/Clignotant – 24V Blink-, Brems- und Schlußlichtlampen – 24V Lámparas traseras, freno e intermitente – 24V Lampade per fanali posteriori, luci di arresto e direzione	43
Lamp kits	44
Displays	45
Packaging, blisters Emballage – Verpackungen – Embalaje – Imballo	46-48
Symbols, marking	49
Lamp bases Culot – Sockelübersicht – Casquillos de lámparas – Attacchi lampade	50

Legend

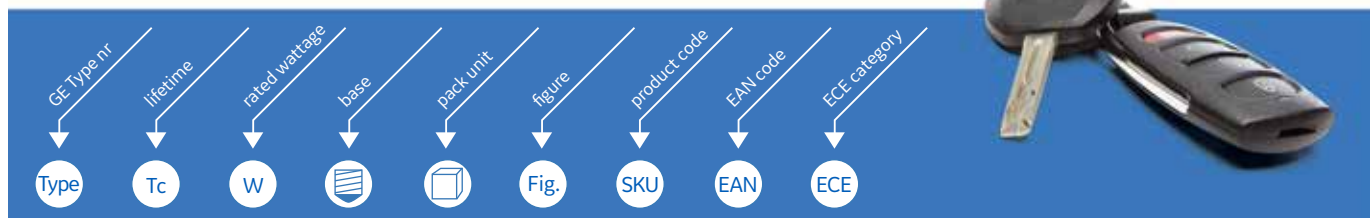

12V Automotive Lamps

front light

D1S 53620	D1R 53740	D2S 53500	D2R 53510	D3S 53660	D3R 53730	D4S 53670	D4R 53680	H1 50310/1U	H3 50340U	H4 50440U	H7 58520U	H9 53100HU	H11 53110HU	HB3 53060U	HB4 53070U
--------------	--------------	--------------	--------------	--------------	--------------	--------------	--------------	----------------	--------------	--------------	--------------	---------------	----------------	---------------	---------------

side turn signals

W5W 501	WY5W 501NA	T4W 2662
------------	---------------	-------------

parking light

T4W 2662	W5W 501	W5W NB 501 NB	H6W 52830U
-------------	------------	---------------------	---------------

fog light

H1 50310/1U	H3 50340U	H7 58520U	H8 53090HU	H10 53080U	H11 53110HU
----------------	--------------	--------------	---------------	---------------	----------------

side signals, warning lights

P21W 1057	PY21W 1056	W21W 7440	WY21W 7440NA
--------------	---------------	--------------	-----------------

dashboard and interior light

W5W 501	W3W 504	1.2W 5301	T4W 2662	C5W 7546	fest 10W 7576	H6W 52830U	LED 60140	LED 60150 60180	LED 60170
------------	------------	--------------	-------------	-------------	---------------------	---------------	--------------	-----------------------	--------------

parking lights

R5W 2619	R10W 2641	P21/5W 1077	P21/4W 1122	W21/5W 7443
-------------	--------------	----------------	----------------	----------------

stop light (CHMSL)

W5W 501	W16W 921
------------	-------------

license plate

R5W 2619	C5W 7546	W5W 501	T4W 2662
-------------	-------------	------------	-------------

side signals, warning lights

P21W 1057	PY21W 1056	W21W 7440	WY21W 7440NA
--------------	---------------	--------------	-----------------

trunk light

R5W 2619	C5W 7546	fest 10W 7576
-------------	-------------	------------------

stop lights

P21W 1057	P21/5W 1077	P21/4W 1122	W21/5W 7443	W21W 7440
--------------	----------------	----------------	----------------	--------------

fog lights

P21W 1057	W21W 7440
--------------	--------------

reverse light

P21W 1057	W16W 921	W21W 7440
--------------	-------------	--------------

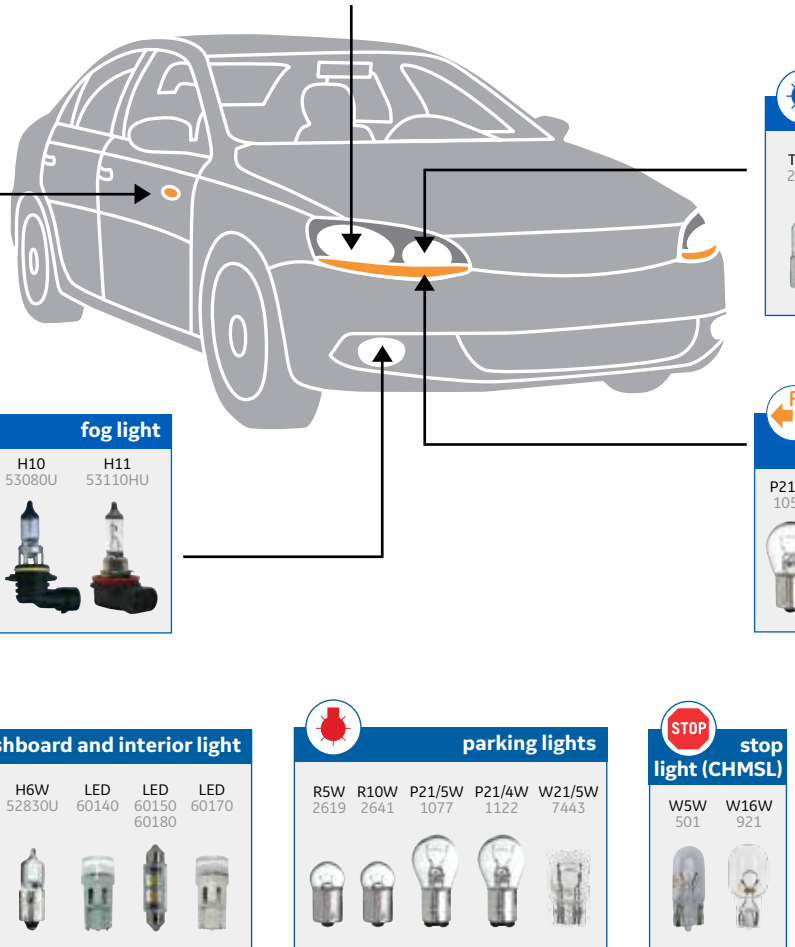

24V Commercial Vehicles

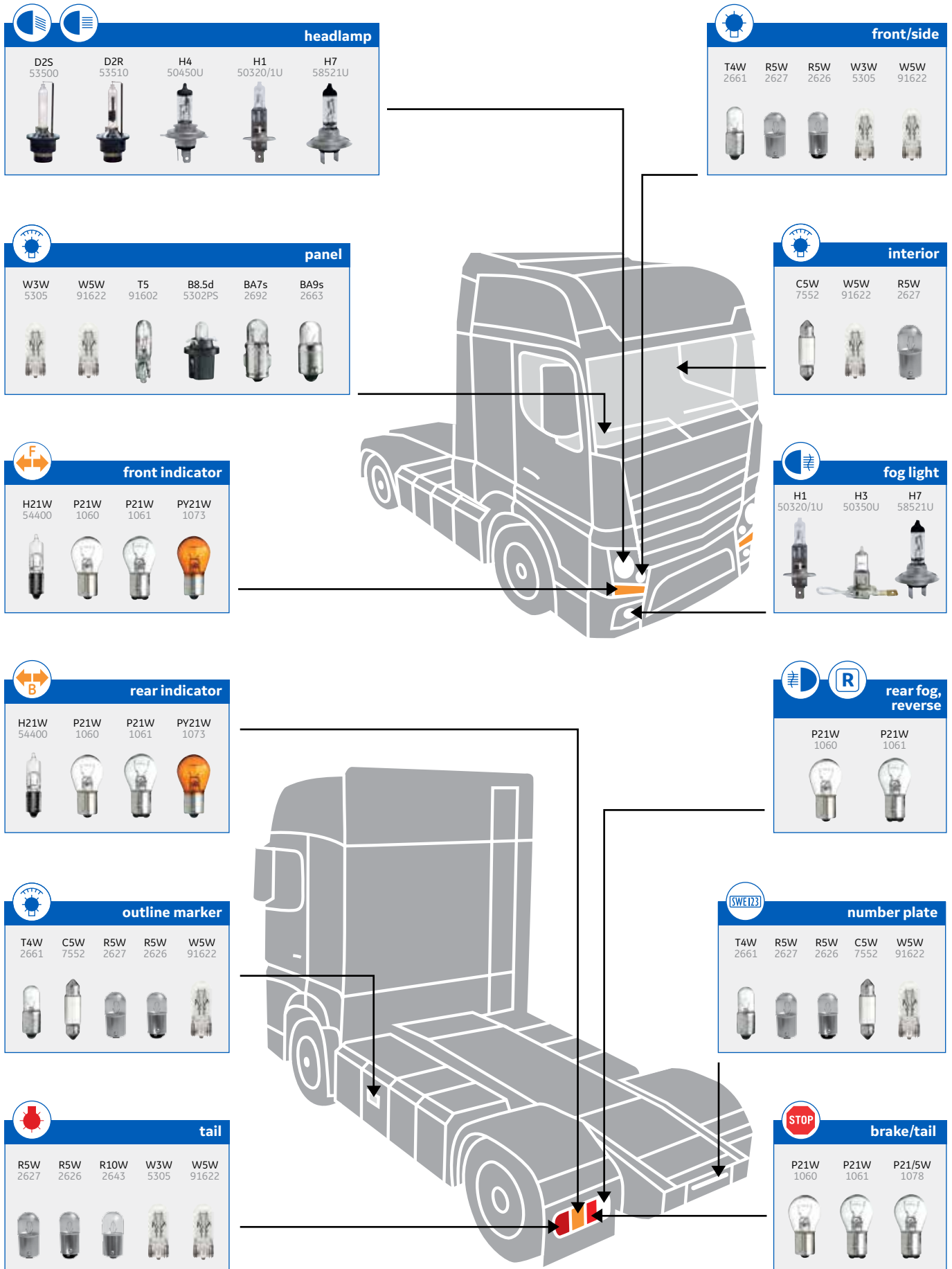

Motorcycles

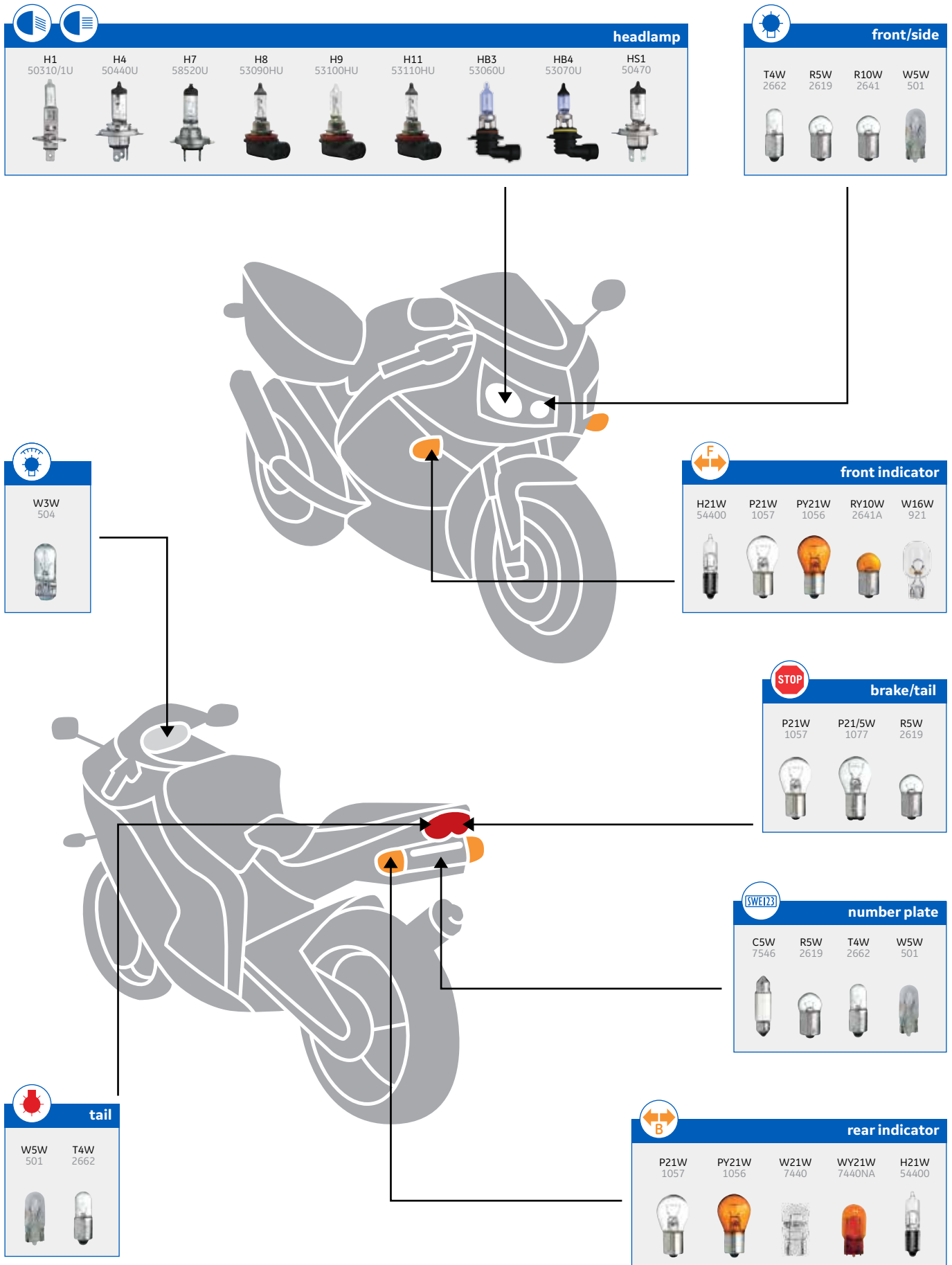

Xenon High Intensity Discharge lamps



GE Xensation - HID - Headlight lamps

- Thanks to our latest lighting technology, GE Xensation lamps provide a major leap in road safety over conventional halogen lamps due to enormous increase in the illuminated field of vision.
- Better visibility and illumination- the light emitted provides the driver with many benefits. It assists the human eye and allows better visibility and improved hazard awareness, allowing the driver to navigate poor driving conditions with increased confidence and with less fatigue.
- Lower power consumption – 35W only instead of 55W (ordinary halogen lamp power consumption).
- Better durability – excellent vibration and shock resistance giving significantly greater reliability.

White Xensation 5500 Kelvin* Light up the road with style and brilliant white light

Up to 20% more light on the road

- Produces a crisp, bright light that is closer to daylight.
- Better visibility in extreme weather conditions, higher visibility in peripheral areas.
- Less fatigue effect during night driving.

* Colour temperature exceeds 5500K in majority of life time.

Xensation Megalight +100 Add safety to your driving

Excellent visibility and illumination, greater illuminated area on the road, up to +100% more light on the road ahead



4200 kelvin



5500 kelvin

D1S, D1R, D2S, D2R, D3S, D3R, D4S, D4R

--	--	--	--	--	--	--	--

Xensation - HID - Headlight lamps

Headlight lamps – upper and lower beam
 Lampes principales
 Hauptscheinwerferlampen
 Lámparas de faro – doble filamento
 Lampade per proiettori – abbagliante ed anabbagliante

Basic types

53620H	D1S	35	PK32D-2	1/4/12	1	78129	0043168781299
53740U	D1R	35	P32D-3	1/4/12	2	93011095	0064894504440
53500U	D2S	35	P32D-2	1/8/32	3	93036	0043168930369
53500U	D2S	35	P32D-2	1/3/12	3	20077	0043168930369
53510U	D2R	35	P32D-3	1/8/32	4	93218	0043168932189
53510U	D2R	35	P32D-3	1/3/12	4	20079	0043168932189
53660U	D3S	35	PK32D-5	1/4/12	1	14178	0043168141789
53730U	D3R	35	PK32D-6	1/4/12	2	93011085	0064894504457
53670U	D4S	35	P32D-5	1/3/12	3	14185	0043168141857
53680U	D4R	35	P32D-6	1/3/12	4	14186	0043168141864

White Xensation 5500 Kelvin*

53750U	D1S	35	PK32d-2	1/4/12	5	93021374	0064894530760
53760U	D2S	35	P32d-2	1/3/12	6	93019380	0064894530333
53770U	D2R	35	P32d-3	1/3/12	7	93019901	0064894530357
53780U	D3S	35	PK32D-5	1/4/12	5	93065985	0064894569807
53790U	D4S	35	P32D-5	1/3/12	6	93065984	0064894570735

* Colour temperature exceeds 5500K in majority of life time.

Megalight +100

	53620CMU	D1S	35	PK32D-2	1/4/12	5	93093786	0064894597800
	53500CMU	D2S	35	P32D-2	1/3/12	6	93093631	0064894597817

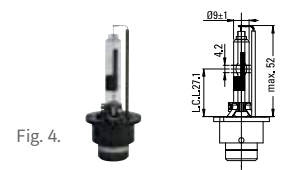
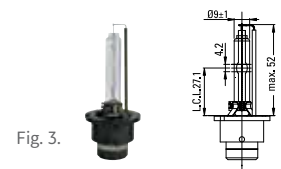
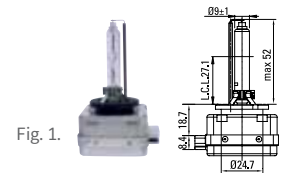

Halogen headlight lamps

lighting your way...

As well as the basic range, GE automotive also offers the premium range, based on special lamp designs. The premium range includes: Megalight Ultra, Megalight Plus, Sportlight, Extra Life, Heavy Star, Rally. The premium lamps have additional benefits in terms of life, colour, vibration resistance or wattage.

The premium lamps are also E1 marked, making their use on the EU roads possible, with the exception of Rally lamps that were designed for off-road usage. Extra life lamps have enhanced life, Megalight Plus and Ultra lamps possess increased luminance, Sportlight halogen lamps give intense blue-white light.

Colour temperature-luminance-life comparisons for the premium range.

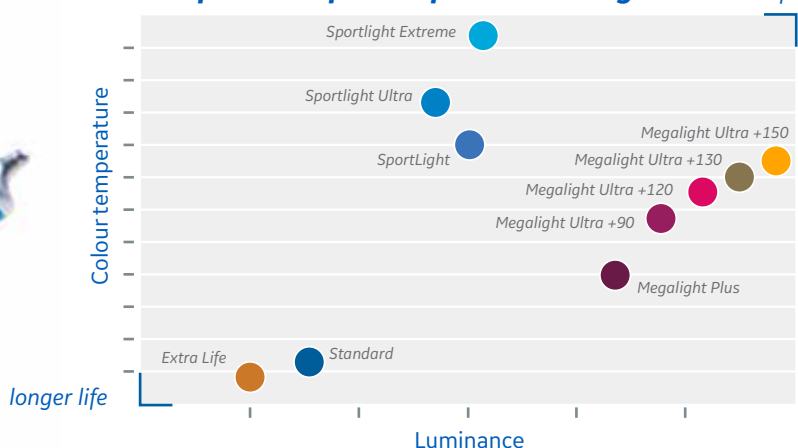

UPGRADE your car with GE premium lamps

	H1	H3
Megalight Ultra +150 up to 150% more light		
Megalight Ultra +130 up to 130% more light	●	
Megalight Ultra +120 up to 120% more light	●	
Megalight Ultra +90 up to 90% more light	●	
Megalight Plus 50-60% more light	●	
Sportlight Extreme Intense white light comparable with xenon – 5000 Kelvin	●	
Sportlight Ultra Intense white light comparable with xenon – 4200 Kelvin	●	
SportLight when you really want to see and be seen	●	
Extra Life better economy for daytime lighting	●	●
Heavy Star - 24V Longer life, increased robustness	●	●
Rally for off-road use only	●	●
GE "Reliable" range quality- performance fully replacable with OEM lamps	●	●

Operational voltage is a critical parameter influencing the life time of the automotive lamps. The life of the lamp is sensitive to the operation voltage of the car, 1% of change of the voltage results in 12-15% change of life with opposite sign.

More light Better visibility Improved driving performance

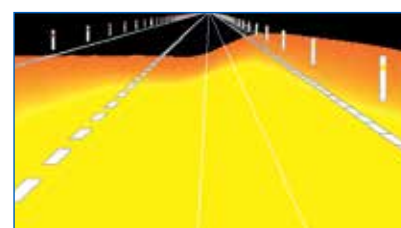
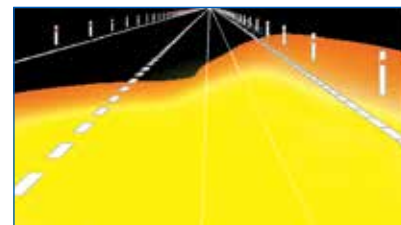
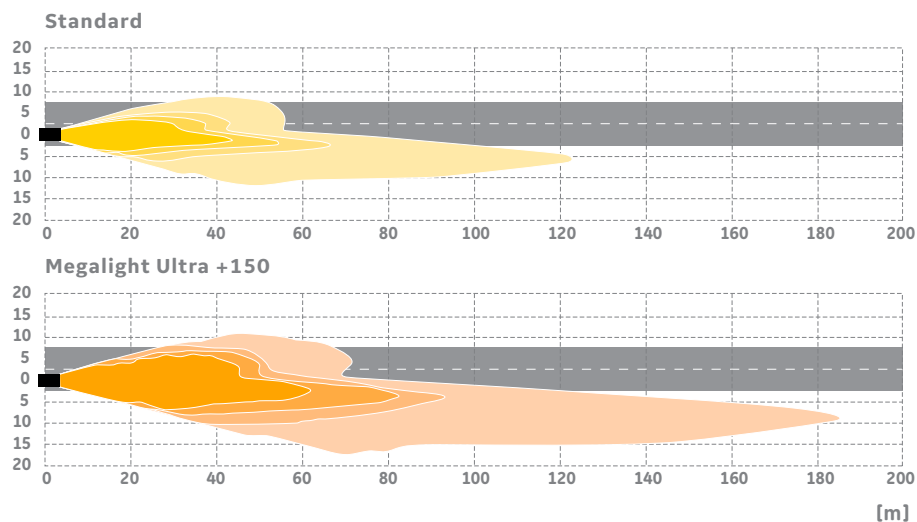

H4	H7	H8	H9	H10	H11	HB3	HB4
●	●						
●	●				●		
●	●				●	●	●
●	●				●	●	●
●	●						
●	●				●		
●	●						
●	●					●	●
●	●						
●	●						
●	●	●	●	●	●	●	●



The special quartz glass used for GE automotive lamps cuts the UV component of light, it means that GE automotive lamps can safely be used in plastic reflectors without the risk of discoloration.

Megalight Ultra +150



Up to 150% more light on the road Maximum safety through ultimate performance

- Brightest halogen headlight lamp - continues to meet and exceed the highest performance levels
- Generate more light output on the road by using an ultra-fine filament and specialized coating system, filled with xenon

Jusqu'à 150% de lumière en plus sur la route

Sécurité maximale grâce à une performance ultime

- Lampe de phare halogène la plus brillante - continue à atteindre et dépasser les niveaux de performance les plus élevés
- Génère plus de lumière sur la route en utilisant un filament ultra-fin et un système de revêtement spécialisé, chargé avec du xénon

Bis zu 150% mehr Licht auf der Strasse Maximale Sicherheit durch ultimative Leistung

- Die hellste, weißeste Halogen-Scheinwerfer-Lampe – erreicht und übertrifft erneut höchste Leistungsbereiche
- Erzeugt mehr Licht auf der Strasse durch die Verwendung eines ultra-dünnen Glühfadens und eines speziellen Coating-Systems, gefüllt mit Xenon Gas

Hasta un 150% más de luz en la carretera

Máxima seguridad gracias a las últimas mejoras técnicas

- La lámpara de faros halógenos más brillante y con luz más blanca – cumpliendo y superando los niveles más exigentes de rendimiento
- Genera más emisión de luz en carretera a través de un filamento ultrafino y con un sistema de recubrimiento especial relleno con xenón

Fino al 150% di luce in piu' sulla strada Massima sicurezza grazie alle massime prestazioni

- Lampada alogena più luminosa - continua a soddisfare e superare i più alti livelli di prestazioni
- Maggiore luminosità sulla strada grazie al filamento ultrafine, al rivestimento funzionale ed allo Xenon.

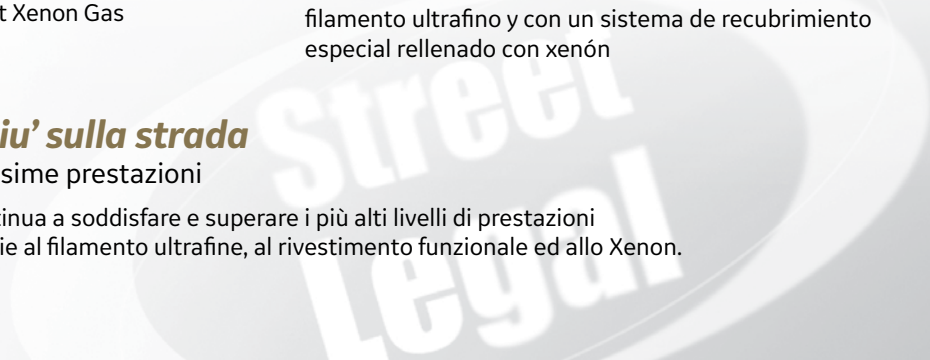

Type	Tc	ECE	W			Fig.	SKU	EAN
------	----	-----	---	--	--	------	-----	-----

Megalight Ultra +150 - Halogen headlight lamps

Headlight lamps - upper and lower beam
 Lampes principales
 Hauptscheinwerferlampen
 Lámparas de fero
 Lampade per proiettori - abbagliante ed anabbagliante

NEW	50440NXNU	250	H4	60/55	P43t	2/10 plastic twin box	1	93080479	0064894583513
NEW	58520NXNU	250	H7	55	PX26d	2/10 plastic twin box	2	93080358	0064894584329

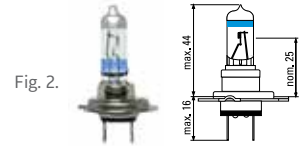
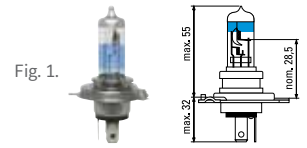

* **Tc (hour)** is the time up to which 63,2 % of tested lamps have ended their lives. Measured according to GE life test specification. The life of the lamp is sensitive to the operation voltage of the car, 1% of change of the voltage results in 12-15% change of life with opposite sign.



 Always change the headlamps by pair.

Megalight Ultra +130



Up to 130% more light on the road

Optimized for breakthrough performance -
Maximum light on the road

- Brightest, whitest halogen headlight lamp - continues to meet and exceed the highest performance levels.
- Safer, easier night driving, with better reflections from road markings and signs.

Bis zu 130 % mehr Licht auf der Straße

Optimiert für bahnbrechende Leistung -
Maximales Licht auf der Straße

- Die hellste und weißeste halogene Scheinwerferlampe – erfüllt und überschreitet weiterhin die höchsten Leistungsniveaus.
- Sicheres und einfacheres Nachtfahren mit besseren Reflexionen von Straßenmarkierungen und Zeichen

Fino al 130% di luce in piu' sulla strada

Ottimizzata per performance avanzate - Massima luminosita' sulla strada.

- Lampada piu' bianca, piu' brillante - Soddisfa e supera i piu' alti livelli di performance.
- Guida notturna piu' facile, sicura, con maggiore visibilita' della segnaletica stradale.

Jusqu'à 130% plus de lumière sur la route

Conception optimisée -
Intensité lumineuse maximale

- Lampe la plus intense en terme de luminosité, lumière la plus blanche - brillante
- Améliore la sécurité de votre conduite de nuit, meilleure réflexions des panneaux de signalization et marques routières

Hasta un 130% más de luz en la carretera

Optimizado para un rendimiento innovador -
Máxima iluminación en la carretera

- Lámpara más brillante y blanca en faros halógenos - En continuo desarrollo para satisfacer y superar los más altos niveles de rendimiento.
- Mayor seguridad y facilidad en conducción nocturna. Mejora la visualización de la señalización vial.

Type	Tc	ECE	W			Fig.	SKU	EAN
------	----	-----	---	--	--	------	-----	-----

Megalight Ultra +130 - Halogen headlight lamps

Headlight lamps - upper and lower beam
 Lampes principales
 Hauptscheinwerferlampen
 Lámparas de faro
 Lampade per proiettori - abbagliante ed anabbagliante

50440XNU	250	H4	60/55	P43t	2/18/72 display	1	93039913	0064894548246
					2/18	1	93066587	0064894548246
					2/20 blister	1	93033325	0064894539817
58520XNU	250	H7	55	PX26d	2/18/72 display	2	93039912	0064894548260
					2/18	2	93066589	0064894548260
					2/20 blister	2	93033266	0064894539824
50310XNU	250	H1	55	P14,5s	2/18/72 display	3	93039914	0064894548239
					2/18	3	93066588	0064894548239
					2/20 blister	3	93039929	0064894548710
53110XNU	250	H11	55	PGJ19-2	2/18/72 display	4	93040088	0064894548888

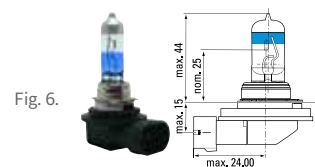
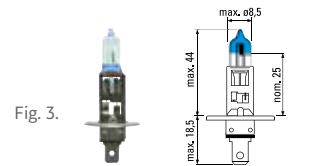
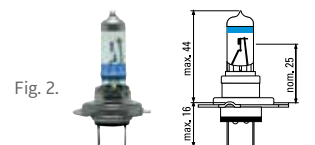
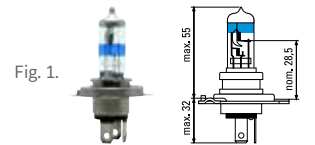

* **Tc (hour)** is the time up to which 63,2 % of tested lamps have ended their lives. Measured according to GE life test specification. The life of the lamp is sensitive to the operation voltage of the car, 1% of change of the voltage results in 12-15% change of life with opposite sign.



Always change the headlamps by pair.

Megalight Ultra +120



Up to 120% more light on the road

New level of performance - optimized design with 100% xenon gas fill.

- Most intense and powerful lamp in terms of luminance, for safer driving
- Improved headlamp illumination level helps in reduction of accidents at night time/in poor visibility conditions

Bis zu 120% mehr Licht auf der Straße

Neues Leistungsniveau – Prozessoptimiertes Design mit 100 %-iger Xenongasfüllung.

- Intensivste und Leistungsstärkste Lampe in Bezug auf Helligkeit, sorgt für sicheres Fahren
- Erhöht die Lichtintensität des Scheinwerfers und verringert somit die Unfallgefahr bei Dunkelheit
- Verbesserte Lichtintensität hilft bei der Verringerung von Unfällen in der Nacht und bei schlechten Sichtverhältnissen

Fino al 120% di luce in piu' sulla strada

Nuovo livello di performance – disegno ottimizzato con il 100% di gas Xenon.

- La lampada fornisce una luce piu' potente ed intensa, per una guida piu' sicura
- Un miglior livello di illuminazione proiettata sulla strada contribuisce a ridurre potenziali incidenti in caso di ridotta visibilità.

Jusqu' à 120% plus de lumière sur la route

Niveau de performance supérieure - conception optimisée, remplie 100% de gaz xénon.

- Lampe la plus intense en terme de luminosité pour la sécurité de votre conduite
- Le niveau d'illumination accrue des projecteurs aide à diminuer les accidents pendant la nuit et lorsque la visibilité est mauvaise.

Hasta un 120% más de luz en carretera

Un nivel más elevado de rendimiento – diseño mejorado con un 100% de gas xenon.

- Con más fuerza e intensidad, en términos de luminosidad, para obtener una conducción más segura
- La mejora del nivel de iluminación en las lámparas principales ayuda en la reducción de accidentes nocturnos o en condiciones de mala visibilidad

--	--	--	--	--	--	--	--	--

Megalight Ultra +120 - Halogen headlight lamps

Headlight lamps – upper and lower beam
 Lampes principales
 Hauptscheinwerferlampen
 Lámparas de faro
 Lampade per proiettori – abbagliante ed anabbagliante

50440SNU	250	H4	60/55	P43t	2/18/72 display	1	98241	0043168982634
					2/20 blister	1	98281	0043168982818
58520SNU	250	H7	55	PX26d	2/18/72 display	2	98264	0043168982658
					2/20 blister	2	98282	0043168982825
50310NU	250	H1	55	P14,5s	2/18/72 display	3	98239	0043168982405
					2/20 blister	3	98266	0043168982665
53810NU	200	HB3	60	P20d	2/18/72 display	4	98436	0043168987325
53070SNU	250	HB4	51	P22d	2/18/72 display	5	98437	0043168987332
53110SNU	250	H11	55	PGJ19-2	2/18/72 display	6	98438	0043168987349

* **Tc (hour)** is the time up to which 63,2 % of tested lamps have ended their lives. Measured according to GE life test specification. The life of the lamp is sensitive to the operation voltage of the car, 1% of change of the voltage results in 12-15% change of life with opposite sign.

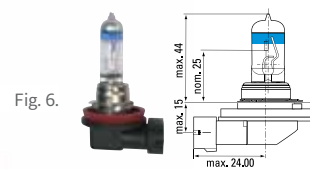
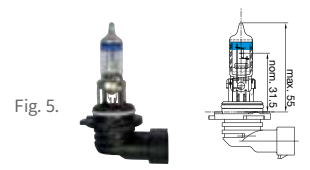
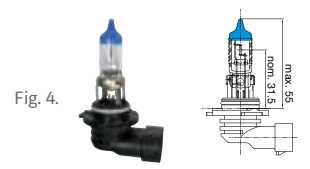
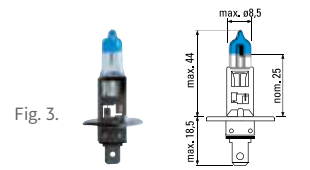
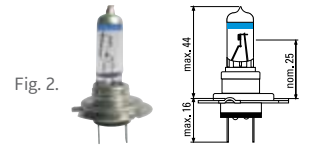
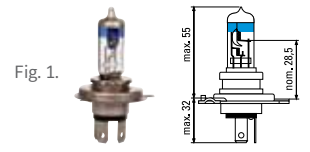



Type	Tc	ECE	W			Fig.	SKU	EAN
------	----	-----	---	--	--	------	-----	-----

Megalight Ultra +90 - Halogen headlight lamps

Headlight lamps – upper and lower beam

Lampes principales

Hauptscheinwerferlampen

Lámparas de faro

Lampade per proiettori – abbagliante ed anabbagliante

50440SXU	350	H4	60/55	P43t	2/18/72 display	1	93013070	0043168735001
					2/20 blister	1	74153	0043168741538
58520SXU	350	H7	55	PX26d	2/18/72 display	2	93013272	0043168969239
					2/20 blister	2	74154	0043168741545
50310XU	350	H1	55	P14,5s	2/18/72 display	3	93013273	0043168969468
					2/20 blister	3	96948	0043168969482
53060XU	200	HB3	60	P20d	2/12/48 display	4	79295	0043168792950
53070SXU	350	HB4	51	P22d	2/12/48 display	5	79296	0043168792967
53110SXU	350	H11	55	PGJ19-2	2/12/48 display	6	79297	0043168792974

* **Tc (hour)** is the time up to which 63,2 % of tested lamps have ended their lives. Measured according to GE life test specification. The life of the lamp is sensitive to the operation voltage of the car, 1% of change of the voltage results in 12-15% change of life with opposite sign.

Up to 90% more light on the road

High performance lamps for visibility, convenience and style

- Improved driving performance at night
- Greater illumination combined with whiter light add safety to your driving.

Bis zu 90% mehr Licht auf der Straße

Verbessern Sie Ihr Fahrverhalten durch stressfreies Sehen, dank des helleren Lichtes

- Verbesserte Sicht bei Nacht.
- Hellere Beleuchtung kombiniert mit blau-weißem Licht bedeutet zusätzliche Sicherheit für Ihre Fahrt.

Fino al 90% di luce in più sulla strada:

lampade ad alta prestazione in termini di visibilità, convenienza e stile

- Migliori prestazioni di guida durante la notte.
- Una migliore illuminazione combinata con una luce più „bianca” aumenta la tua sicurezza.

Jusqu'à 90% plus de lumière sur la route

Lampes à haute performance pour le confort visuel et style

- Meilleure performance de conduite dans la nuit
- Luminosité accrue combiné avec lumière plus blanche augmente la sécurité de votre conduite.

Hasta un 90% más de luz en carretera

Alto rendimiento. Lámparas que aúnan visibilidad, comodidad y estilo

- Para una mejor conducción nocturna.
- Una mayor iluminación combinada con una luz blanca más intensa. Añade seguridad a la conducción.

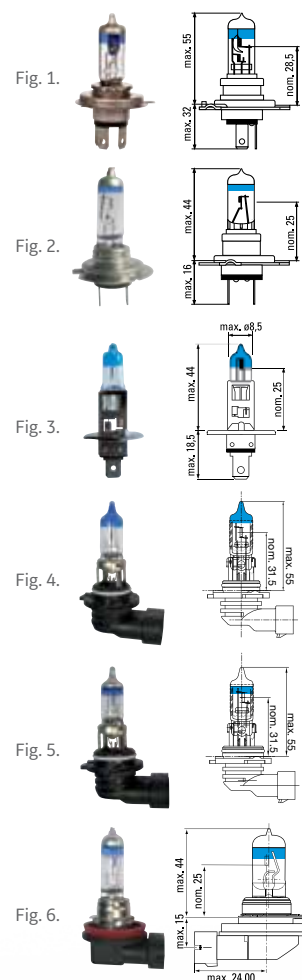



Type	Tc	ECE	W			Fig.	SKU	EAN
Megalight Plus 50, 60 - Halogen headlight lamps								

Headlight lamps – upper and lower beam

Lampes principales

Hauptscheinwerferlampen

Lámparas de faro

Lampade per proiettori – abbagliante ed anabbagliante

50440MPU	300	H4	60/55	P43t	2/18/72 display	1	93012268	0043168916189
					1/12/48 display	1	12791	0043168127912
					2/20 blister	1	93361	0043168933612
58520MPU	500	H7	55	PX26d	2/18/72 display	2	93012270	0043168937689
					1/20/80 display	2	12904	0043168129046
					2/20 blister	2	19759	0043168197595
50310MPU	600	H1	55	P14,5s	2/18/72 display	3	93012269	0043168936255
					1/20/80 display	3	12896	0043168128964
					2/20 blister	3	19758	0043168197588

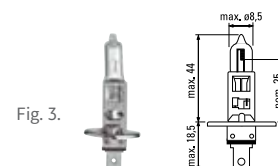
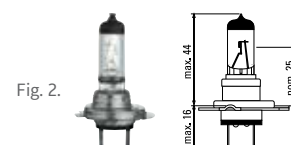
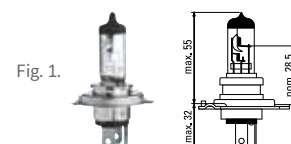

* **Tc (hour)** is the time up to which 63,2 % of tested lamps have ended their lives. Measured according to GE life test specification. The life of the lamp is sensitive to the operation voltage of the car, 1% of change of the voltage results in 12-15% change of life with opposite sign.

Up to 50-60% more light on the road

- Special high luminance lamp design
- Longer beam
- Brighter illumination

50-60% mehr Licht auf der Straße

- Spezielles Design für größtmögliche Beleuchtungsstärke
- Größere Leuchtweite
- Hellere Beleuchtung

Fino al 50-60% di luce in più sulla strada

- Speciale design della lampada ad alta luminosità
- Fascio più lungo
- Luminosità più brillante

Jusqu'à 50 à 60% plus de lumière sur la route

- Une conception pour une luminance plus élevée
- Un faisceau plus long
- Une illumination plus brillante

Hasta un 50-60% más de luz en carretera

- Diseño especial de la lámpara de alta luminosidad
- Haz luminoso de mayor alcance
- Iluminación más intensa

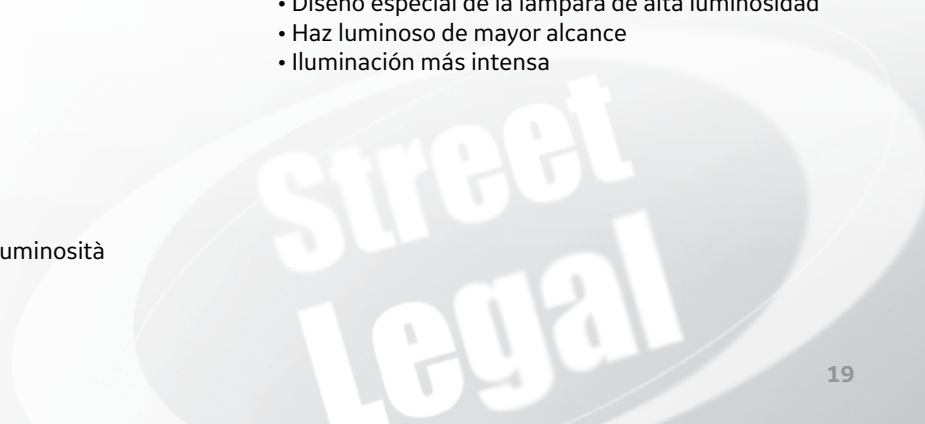

Sportlight



When you really want to see and be seen

Intense blue-white light up to 50% more light on the road, or faster signal

- Higher visibility in peripheral viewing
- Better visibility in extreme weather conditions
- Faster signal, earlier notice - miniature lamps

Wenn Sie wirklich gut sehen und gut gesehen werden wollen

Intensives blau-weißes Licht mit Xenon Effekt, welches bis zu 50% mehr Licht auf die Straße bringt

- Bessere Sicht in den Außenrandbereichen um zu sehen und gesehen zu werden
- Bessere Sichtbarkeit bei extremen Wetterbedingungen
- Verbesserte und schnellere Reaktionszeit - Miniaturlampen

Se volete davvero vedere ed essere visti

Un'intensa luce di colore blu-bianca che garantisce un'illuminazione della strada superiore del 50%

- Visibilità maggiore nella visione periferica "per vedere ed essere visti"
- Migliore visibilità in condizioni atmosferiche difficili
- Segnale più veloce, che permette di essere visti vedere prima - lampade miniatura

Lorsque vous voulez vraiment voir et être vu

Une lumière intense bleue-blanche et jusqu'à 50% plus de lumière sur la route, ou un signalment et un aperçu plus rapide

- Une visibilité périphérique plus élevée et dans des conditions climatiques extrêmes
- Un signalment et un aperçu plus rapide - lampes miniatures

Para ver y ser visto con claridad

Luz intensa blanca azulada, que ofrece hasta un 50% más de iluminación en carretera

- Mayor visibilidad en el campo de visión periférico
- Mayor visibilidad en condiciones climáticas extremas - lámparas miniatura



Sportlight Ultra - Halogen headlight lamps Up to +30% more light on the road, "Xenon look" 4200K							

Headlight lamps – upper and lower beam
 Lampes principales
 Hauptscheinwerferlampen
 Lámparas de fero
 Lampade per proiettori – abbagliante ed anabbagliante

50440SBU	250	H4	60/55	P43t	2/18/72	1	90901	0043168909013
					2/20 blister	1	93012846	0064894521812
58520SBU	250	H7	55	PX26d	2/18/72	2	90902	0043168909020
					2/20 blister	2	93012861	0064894521904
50310SBU	250	H1	55	P14,5s	2/18/72	3	90900	0043168909006
					2/20 blister	3	93012845	0064894521805

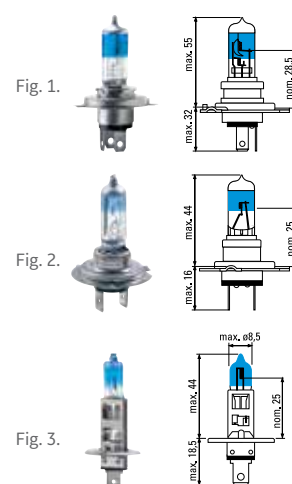

Tc (hour) is the time up to which 63,2 % of tested lamps have ended their lives. Measured according to GE life test specification. The life of the lamp is sensitive to the operation voltage of the car, 1% of change of the voltage results in 12-15% change of life with opposite sign.

Intense white light comparable with xenon – 4200 Kelvin

- Up to 30% more light on the road
- Higher visibility in peripheral viewing
- Better visibility in extreme weather conditions

Une lumière intense bleu-blanche similaire aux lampes xenon – 4200 Kelvin

- jusqu'à 30% plus de lumière sur la route
- Une visibilité périphérique plus élevée et dans des conditions climatiques extrêmes

Intensives blau-weißes Licht mit Xenon Effekt – 4200 Kelvin

- Welches bis zu 30% mehr Licht auf die Straße bringt
- Bessere Sicht in den Außenrandbereichen um zu sehen und gesehen zu werden
- Bessere Sichtbarkeit bei extremen Wetterbedingungen

Luz intensa blanca azulada 4200 Kelvin

- Ofrece hasta un 30% más de iluminación en carretera
- Mayor visibilidad en el campo de visión periférico
- Mayor visibilidad en condiciones climáticas extremas

Un'intensa luce di colore blu-bianca – 4200 Kelvin

Un'intensa luce di colore blu-bianca che garantisce un'illuminazione della strada superiore del 30%

- Garantisce un'illuminazione della strada superiore del 30%
- Maggiore visibilità periferica: "per vedere ed essere visti"
- Migliore visibilità in condizioni atmosferiche avverse





--	--	--	--	--	--	--	--	--

Sportlight Extreme - Halogen headlight lamps *Up to 40% more light on the road, "Xenon look" 5000K*

Headlight lamps - upper and lower beam
 Lampes principales
 Hauptscheinwerferlampen
 Lámparas de faro
 Lampade per proiettori - abbagliante ed anabbagliante

	50440SUP	250	H4	60/55	P43t	2/10 plastic twin box	1	93093768	0064894597824
	58520SUP	250	H7	55	PX26d	2/10 plastic twin box	2	93093767	0064894598043
	50310SUP	250	H1	55	P14,5s	2/10 plastic twin box	3	93093769	0064894596094
	53110SUP	250	H11	55	PGJ19-2	2/10 plastic twin box	4	93093770	0064894596087

Tc (hour) is the time up to which 63,2 % of tested lamps have ended their lives. Measured according to GE life test specification. The life of the lamp is sensitive to the operation voltage of the car, 1% of change of the voltage results in 12-15% change of life with opposite sign.

Intense white light comparable with xenon - up to 5000 Kelvin

- Greater illuminated area on the road ahead
- Up to 40% more light on the road
- It assists the human eye and allows better visibility and improved hazard awareness, allowing the driver to navigate poor driving conditions with increased confidence and with less fatigue

Intensives weißes Licht, vergleichbar mit Xenon - 5000 Kelvin

- Größerer beleuchteter Bereich auf der Strasse
- Bis zu 40% mehr Licht auf der Strasse
- Es hilft dem menschlichen Auge und sorgt für bessere Sicht und Erkennbarkeit von Gefahrenstellen und erlaubt dem Fahrer selbst unter widrigen Fahr-Bedingungen mit erhöhtem Selbstvertrauen und weniger Müdigkeit zu fahren

Intensa luce bianca Xenon 5000° Kelvin

- Maggiore area frontale illuminata
- Fino al 40% in più di luce sulla strada
- Aiuta l'occhio umano e consente una migliore visibilità ed una migliore consapevolezza dei rischi, permettendo al conducente di guidare in condizioni sfavorevoli con maggiore sicurezza e meno fatica

Lumière blanche intense comparable, Avec le xénon - 5000 Kelvin

- Plus grande zone éclairée sur la route
- Jusqu'à 40% de lumière en plus sur la route
- Aide l'œil humain lui permettant une meilleure visibilité et une meilleure sensibilisation aux dangers, permet au conducteur de bien guider dans de mauvaises conditions de conduite avec une bonne assurance et moins de fatigue

Luz blanca e intensa comparable con la lámpara xenón - 5000 Kelvin

- Mayor área iluminada en la visión frontal de la carretera
- Hasta un 40% más de luz en la carretera
- Ayuda al ojo humano y permite una mejor visibilidad, así como una rápida conciencia del peligro, permitiendo al conductor conducir en malas condiciones con una mayor confianza y con menos fatiga.

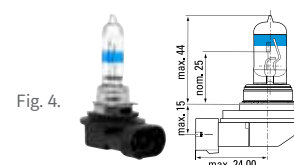
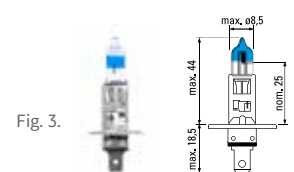
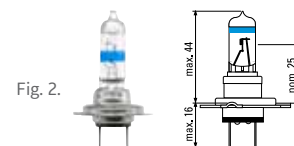
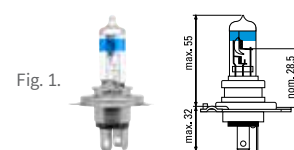

Extra Life



Extended long lifetime

Double the life of standard bulbs

- Suitable for Daytime Running Light (DRL) use
- Ensures safe driving during day and night



Verlängerte Lebensdauer / Superlonglife

Lebensdauerverdoppelung gegenüber Standardglühlampen

- Besonders geeignet auch als Tagfahrlichtlampen-Generation (DRL)
- Sorgt für sicheres Fahren bei Tag und bei Nacht



Durée de vie extra longue

Double la vie des lampes standard

- Convenable pour l'utilisation DRL
- Pour conduire en sécurité - spécialement conçues pour la conduite de jour comme de nuit



Vida útil prolongada

Duplica la vida útil de las bombillas estándar

- Adecuada para su uso como luz diurna (DRL)
- Garantiza una conducción segura día y noche



Lunga durata

Doppia durata rispetto alle tradizionali lampadine

- Ideale come lampadine DRL (Daytime Running Light)
- Garantisce una guida sicura durante il giorno e la notte



--	--	--	--	--	--	--	--

Extra Life - Halogen headlight lamps

Headlight lamps – upper and lower beam
 Lampes principales
 Hauptscheinwerferlampen
 Lámparas de faro
 Lampade per proiettori – abbagliante ed anabbagliante

50440DPU	3500	H4	60/55	P43t	2/18/72 display	1	93012336	0043168174626
					2/20 blister	1	19682	0043168196826
					1/10 blister	1	93058120	0064894567582
					1/10/100	1	95396	0043168953962
58520DPU	1250	H7	55	PX26d	2/18/72 display	2	93012303	0043168174633
					2/20 blister	2	19686	0043168196864
					1/10 blister	2	93058121	0064894567599
50310DPU	2000	H1	55	P14,5s	2/18/72 display	3	93012337	0043168174657
					1/10/100	3	93011331	0064894508158
					2/20 blister	3	19685	0043168196857
50340DPU	2500	H3	55	PK22s	1/10/100	4	17464	0043168174640

Extra Life - Miniature lamps

Tail, direction, parking and indicator lamps
 Feu rouge/clignotant/Feu de position/Répétiteur latéral
 Blink-, Brems- und Schlußlichtlampen
 Lámparas traseras, marcha atrás e indicadoras
 Lampade per fanali posteriori, luci di arresto e direzione

1057LFD	1000	P21W	21	BA15s	1/10/200	5	77049	0043168770491
					2/20 blister	5	23284	0043168232845
1056LFD	3000	PY21W	21	BAU15s	1/10/200	6	77091	0043168770910
1077LFD	1000/5000	P21/5W	21/5	BAY15d	1/10/200	7	77050	0043168770507
					2/20 blister	7	23285	0043168232852
1122LFD	1300	P21/4W	21/4	BAZ15d	1/10/200	7	77090	0043168770903
2619LFD	1500	R5W	5	BA15s	1/10/200	8	77051	0043168770514
					2/20 blister	8	23286	0043168232869
2641LFD	1600	R10W	10	BA15s	1/10/200	8	77052	0043168770521
7546LFD	3000	C5W	5	SV8,5	1/10/200	9	77054	0043168770545
					2/20 blister	9	23308	0043168233088
930LFD	1500	W5W	5	W2,1x9,5d	1/10/200	10	77048	0043168770484
					10/200	10	70244	0043168702447
2662LFD	1500	T4W	4	BA9s	1/10/200	11	77059	0043168770590
					2/20 blister	11	23292	0043168232920
52830LFD	1000	H6W	6	BAX9s	1/10/100	12	77053	0043168770538

* **Tc (hour)** is the time up to which 63,2 % of tested lamps have ended their lives. Measured according to GE life test specification. The life of the lamp is sensitive to the operation voltage of the car, 1% of change of the voltage results in 12-15% change of life with opposite sign.

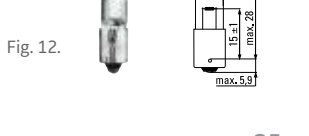
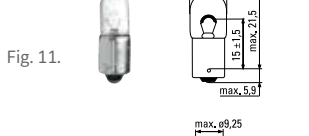
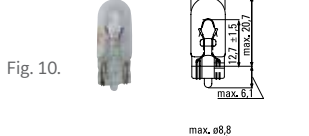
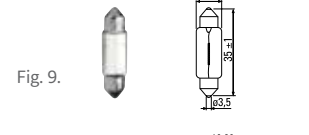
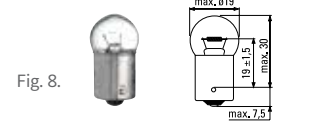
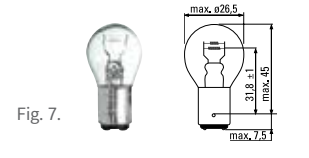
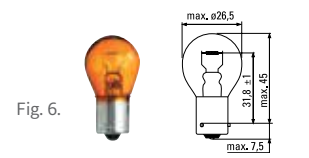
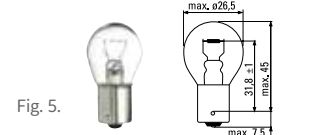
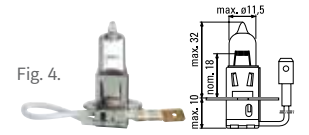
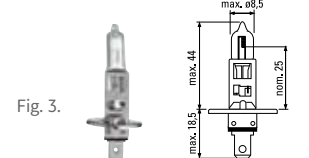
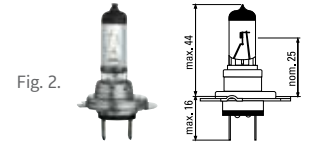
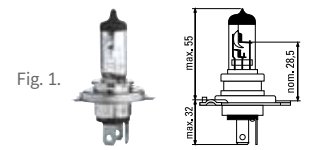



UK High wattage headlight and foglight lamps for OFF ROAD use only

FR Lampes phares et anti-brouillard à haute puissance pour l'utilisation 'OFF-ROAD'

DE Hochwattscheinwerfer- und Nebelscheinwerferlampen die speziell für „OFF ROAD“ oder als „RALLYLAMPEN“ genutzt werden können.

ES Faros delanteros y luces anti-neblia de alta potencia para uso exclusivo EN VÍAS NO OFICIALES

IT Fari anteriori e fari fendinebbia ad alto wattaggio esclusivamente per uso OFF ROAD



Type	ECE	W			Fig.	SKU	EAN
Rally - Halogen headlight lamps							

Headlight lamps – Rally types are not allowed on public roads

Lampes principales RALLYE – Lampes rallye UTILISATION SUR ROUTE INTERDITE

Hauptscheinwerferlampen – Rallye-Typen sind im Bereich der StVZO nicht zugelassen

Lámparas de faro y proyector - halógena – Las lámparas de rally no están permitidas en vías públicas

Lampade per proiettori - Alogene - E' vietato l'impiego di lampade "Rally" su strade pubbliche

52140U	100	P14,5s	1/10/100	1	34874	9004102348740
			1/10 blister	1	35434	0043168354349
50370U	100	P14,5s/R	1/10/100	1	34875	9004102348757
52130U	100	Pk22s	1/10/200	2	34876	9004102348764
			1/10 blister	2	37963	0043168379632
52100U	100/80	P43t	1/10/100	3	35974	0043168359740
52100U	100/90	P43t	1/10/100	3	18195	0043168181952
52030U	100/80	P45t	1/10/100	4	35975	0043168359757

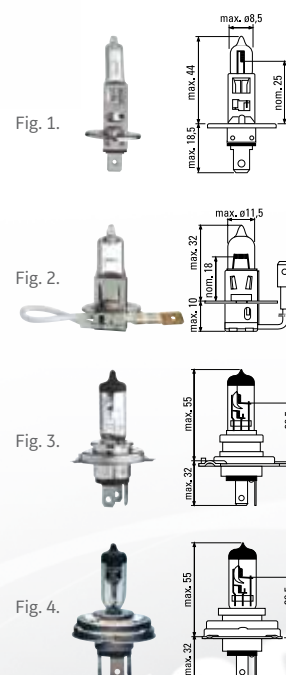

Adjustable LED Daytime Running Lamp

Maximum, instant visibility



Why DRL?

Many countries have encouraged or required daytime use of low-beam headlamps. After 2011 in EU all new car platforms will come with dedicated DRL units. **Existing car owners have the option to install DRL units** available on the aftermarket to increase vehicle conspicuity, **utilizing these instead of the required low beams.** Adding daytime light to **existing cars** is beneficial from many aspects: safety, environment, fuel consumption.

LED DRL vs Low beam used as DRL

- Designed for DRL function
- Energy efficient
- Excellent visibility
- Long life – up to 10x longer operating time when compared to standard Halogen systems

SKU	Description	Pack structure	EAN code
70331	GE LED AUTO DRL31	1/4 (set)	0043168703314

LED Retrofit Miniature lamps

Type	Replacement	CCT	W	Diagram	Fig.	SKU	EAN	
60140	501, 501NB, 930, 930LFD	4000	0.5	W2.1x9.5d	2/20	1	93080381	0064894584046
60150	7576	4000	0.5	SV8.5-8	1/10	2	93080379	0064894584060
60170	501, 501NB, 930, 930LFD	6000	0.5	W2.1x9.5d	2/20	3	93080063	0064894580550
60180	7576	6000	0.5	SV8.5-8	1/10	2	93080064	0064894580561

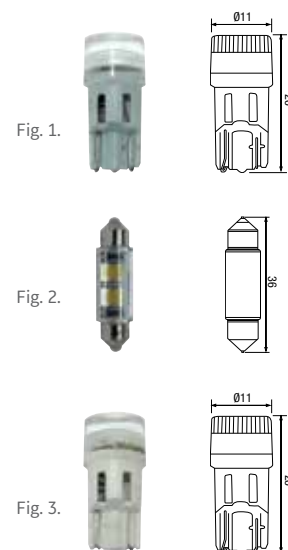

* These LED bulbs are for interior use only.
 Cette ampoule LED est prévue pour une utilisation intérieur uniquement.
 Diese LED-Leuchten sind ausschließlich für die Benutzung im Innenbereich vorgesehen.
 Estas lámparas LED son solo para uso interior.
 Questa lampadina al LED é esclusivamente per uso interno.

Motorcycle



Multicolor Motorcycle lamps

Visibly different - see and be seen with our distinctive colour

- unique color that makes you more conspicuous than the rest of the traffic
- up to 30% more light on the road

Megalight Ultra +120 lamps for motorcycle use

Turn night into day

- New level of performance and safety
- Up to 120% more light on the road

Sportlight +50 lamps for motorcycle use

Highlight the road ahead

- Intense Blue white light
- Up to 50% more light on the road

--	--	--	--	--	--	--	--	--

Headlight lamps – upper and lower beam
 Lampes principales
 Hauptscheinwerferlampen
 Lámparas de faro
 Lampade per proiettori – abbagliante ed anabbagliante

Multicolor Motorcycle Lamp – Halogen headlight lamps

50440MCU	480	H4	60/55	P43t	1/20	1	84489	0043168844895
58520MCU	250	H7	55	PX26d	1/20	2	84491	0043168844918

Megalight +120 Motorcycle - Halogen headlight lamps

50440SNU	250	H4	60/55	P43t	1/20	3	98714	0043168987141
58520SNU	250	H7	55	PX26d	1/20	4	98715	0043168987158
53110SNU	250	H11	55	PGJ19-2	1/20	5	98713	0043168987134

Sportlight +50 Motorcycle – Halogen headlight lamps

50440SPU	480	H4	60/55	P43t	1/20	6	98716	0043168987165
58520SPU	250	H7	55	PX26d	1/20	7	98717	0043168987172
53110SPU	250	H11	55	PGJ19-2	1/20	8	98766	0043168987660

* **Tc (hour)** is the time up to which 63,2 % of tested lamps have ended their lives. Measured according to GE life test specification. The life of the lamp is sensitive to the operation voltage of the car, 1% of change of the voltage results in 12-15% change of life with opposite sign.

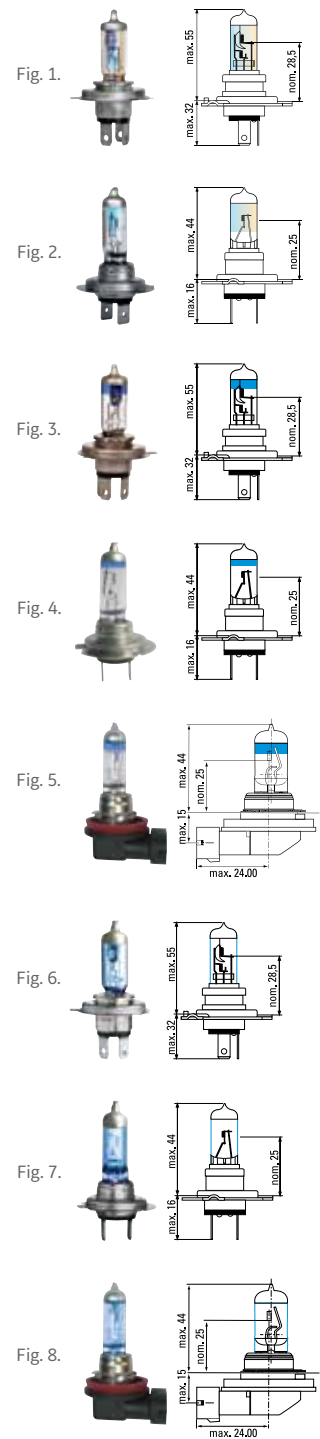

Type	ECE	W			Fig.	SKU	EAN
------	-----	---	--	--	------	-----	-----

Headlight lamps – upper and lower beam
Lampes principales
Hauptscheinwerferlampen
Lámparas de fero
Lampade per proiettori – abbagliante ed anabbagliante

HB3	53060U	HB3	60	P20d	1/10/100	1	36474	0043168364744
					1/10 blister	1	18266	0043168182669
HB4	53070U	HB4	51	P22d	1/10/100	2	36472	0043168364720
					1/10 blister	2	18267	0043168182676
H10	53080U	H10	42	PY20d	1/10/100	2	12905	0043168129053
HIR 2	54430U	HIR 2	55	PX22d	1/6/48	3	93051880	0043168964845
H27	54480U	H27/1	27	PG13	1/10/100	4	93027328	0064894536397
	54490U	H27/2	27	PGJ13	1/10/100	5	93027329	0064894536403

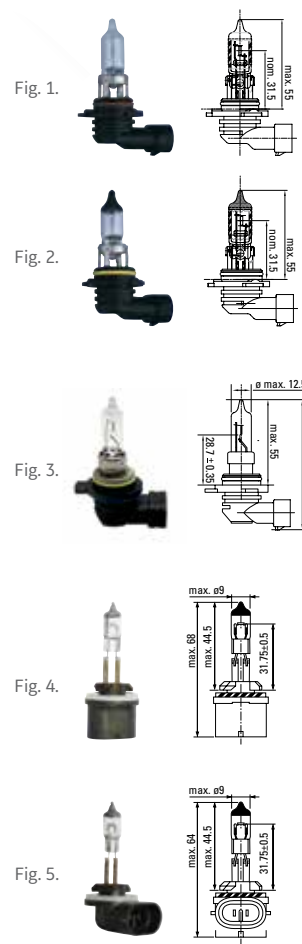

replacable with OEM lamps

Miniature lamps

- side signals, warning lamps
- stop lamps
- fog lamps
- license plate
- reverse lamps
- parking lamps
- dashboard lamps
- interior lamps
- indicator lamps
- side turn signal lamps

UPGRADE your car with
GE premium lamps

Extra Life

better economy for daytime lighting, 2x longer life

SportLight

when you really want to **see and be seen**

Heavy Star

GE "Reliable" range

quality- performance fully replaceable with OEM lamps



P21W

P21/4W

P21/5W



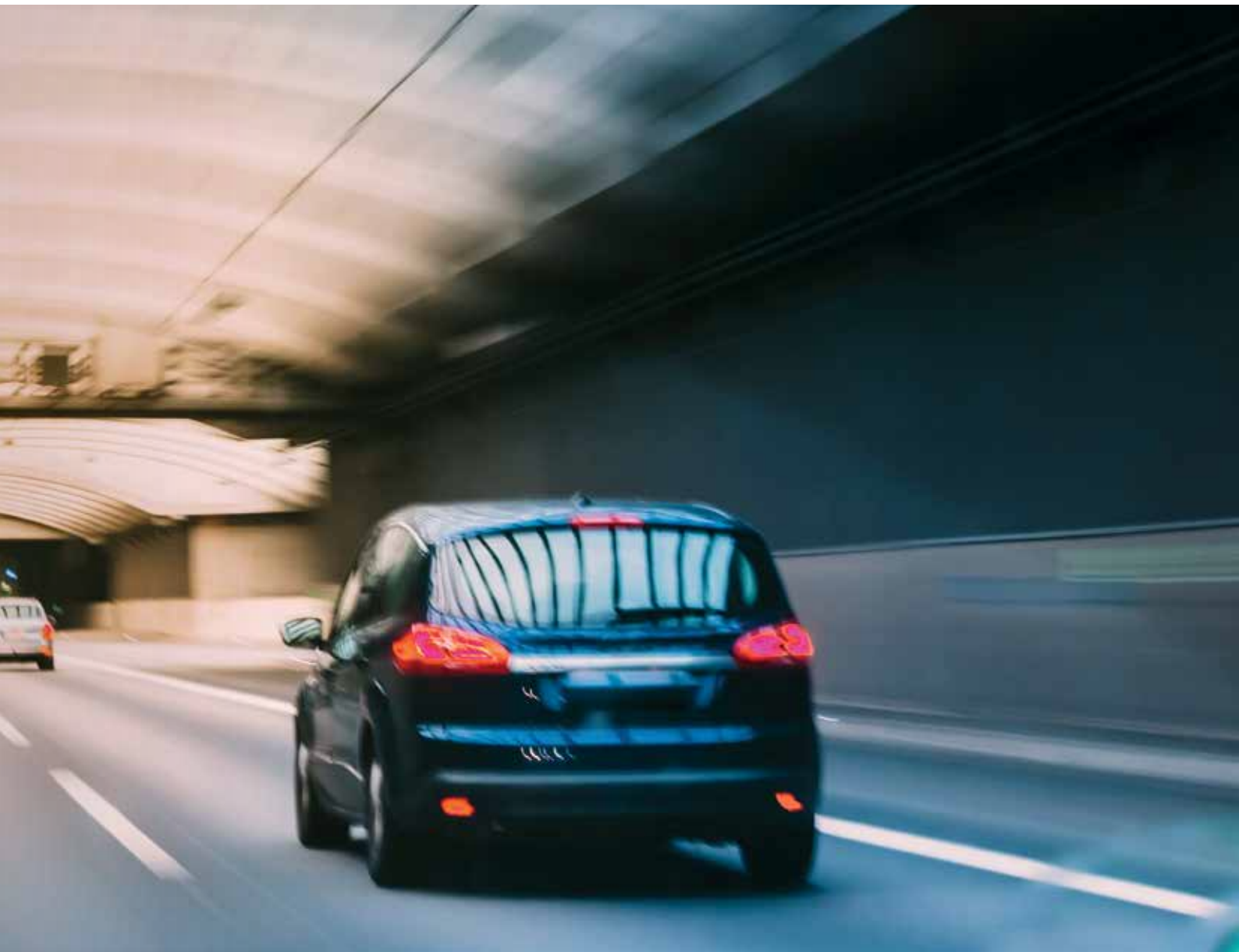

PY21W

R5W

R10W

T4W

W5W

C5W



Type	ECE	W			Fig.	SKU	EAN
Tail, stop and direction lamps Feu rouge/stop/clignotant Brems-, Blink- und Schlußlichtlampen Lámparas traseras, freno e intermitente Lampade per fanali posteriori, luci di arresto e direzione							
1056	PY21W	21	BAU15s	1/10/200	1	37964	0043168379649
				10/200	1	17248	9004102328193
				2/20 blister	1	17133	0043168354073
1057	P21W	21	BA15s	1/10/200	2	37894	0043168378949
				10/200	2	17218	9004102238058
				2/20 blister	2	17131	0043168354066
1058	P21W	21	BA15d	10/200	3	17219	9004102349914
1156		32 CP	BA15s	10/200	2	77369	0043168773690
1077	P21/5W	21/5	BAY15d	1/10/200	5	37896	0043168378963
				10/200	5	17228	9004102238096
				2/20 blister	5	17130	0043168354097
1098		20/5	BA15d	10/200	5	27736	0043168277365
1122	P21/4W	21/4	BAZ15d	10/200	5	17241	9004102238546
				2/20 blister	5	35931	0043168359313
1157	1157 ANSI	32/3 CP	BAY15d	10/200	5	17247	0043168357197
				2/20 blister	5	37969	0043168379694
7440	W21W	21	W3x16d	1/10/100	6	93458	0043168934589
				2/20 blister	6	93447	0043168934473
7440NA	WY21W	21	WX3x16d	1/10/100	7	76090	0043168760904
				2/20 blister	7	76091	0043168760911
7443	W21/5W	21/5	W3x16q	1/10/100	8	93448	00 43168934480
				2/20 blister	8	512863	5994101128631
7443NA	21/5W	21/5	W3x16q	1/10/100	9	93077671	0064894582066
53990	H21W	21	BAY9S	10/200	10	94714	0043168947145

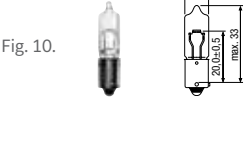
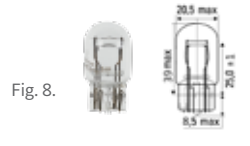
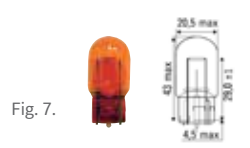
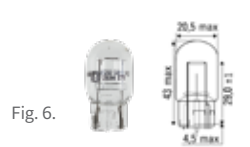
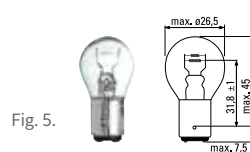
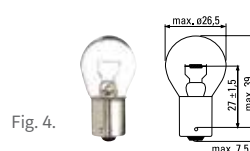
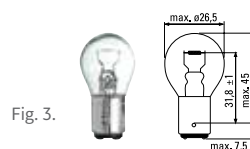
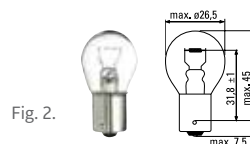
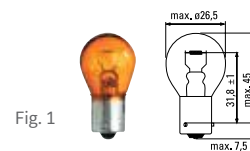

Type	ECE	W			Fig.	SKU	EAN
------	-----	---	--	--	------	-----	-----

Interior lamps
Lampes éclairage intérieur
Lampen für Innenbeleuchtung
Lámparas de interior
Lampade per illuminazione interna

7546	C5W	5	SV8,5-8	1/10/200	1	37912	0043168379120
				10/200	1	27771	9004102238409
				2/20 blister	1	17129	0043168354608
91701		3	SV7	10/200	2	73599	0043168936668
7575		5	SV8,5-8	10/200	3	27781	0043168379557
				2/20 blister	3	37956	0043168379564
7576	DIN 72601K	10	SV8,5-8	1/10/200	3	37913	0043168379137
				10/200	3	27793	9004102238683
				2/20 blister	3	35463	0043168354639
91715		10	SV8,5-8	10/200	5	73600	0043168387781
91735		10	SV8,5-8	10/200	4	73598	0043168132541
				1/10/200	4	93436	0043168379908
7592		15	SV8,5-8	10/200	6	27801	9004102349440
				2/20 blister	6	38803	0043168388030
7593		18	SV8,5-8	10/200	6	27803	9004102349457
7585		10	SV8,5-8	2/20 blister	4	39459	0043168394598

Fig. 1.

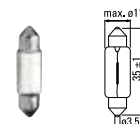

Fig. 2.



Fig. 3.

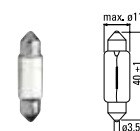

Fig. 4.

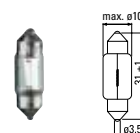
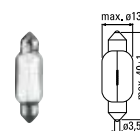

Fig. 5.



Fig. 6.



Miniature halogen lamps
Lampes Halogène miniature
Miniatur-Halogenlampen
Lámparas halógenas miniatura
Lampade miniature alogene

58540		5	BA9s	1/20	7	34930	9004102349303
58560		10	BA9s	1/20	7	34926	9004102349266
52830U	H6W	6	BAX9s	1/10/100	8	38849	0043168388498
				1/10 blister	8	38850	0043168388504

Fig. 7.

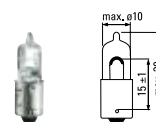
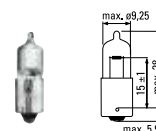

Fig. 8.



replaceable with OEM lamps

Type	ECE	W			Fig.	SKU	EAN
Tail, direction, parking and indicator lamps Feu rouge/clignotant/Feu de position/Répetiteur latéral Blink-, Brems- und Schlußlichtlampen Lámparas traseras, marcha atrás e indicadoras Lampade per fanali posteriori, luci di arresto e direzione							
2619	R5W	5	BA15s	1/10/200	1	37897	0043168378970
				10/200	1	17253	9004102238270
				2/20 blister	1	17136	0043168353984
2619T	R5W	5	BA15s	10/200	2	20112	0043168201124
2641	R10W	10	BA15s	1/10/200	1	37899	0043168378994
				10/200	1	17256	9004102238348
				2/20 blister	1	17134	0043168354059
2641T	R10W	10	BA15s	10/200	3	20113	0043168201131
2696	DIN 72601J	2	BA7s	10/200	4	27393	9004102349242
				2/20 blister	4	38855	0043168388559
2656		3	BA9s	10/200	5	26741	0043168936927
2660		2	BA9s	10/200	5	26742	9004102349358
				2/20 blister	5	37960	0043168379601
2662	T4W	4	BA9s	1/10/200	6	37900	0043168379007
				10/200	6	27347	9004102238379
				2/20 blister	6	17137	0043168354509
5301		1,2	W2x4,6d	1/10/200	7	42804	0043168379076
				10/200	7	42799	9004102238669
				2/20 blister	7	35451	0043168354516
91605		2	W2x4,6d	10/200	7	97987	0043168936521

Fig. 1.



Fig. 2.

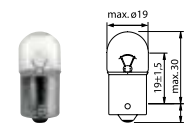

Fig. 3.

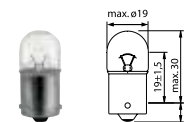

Fig. 4.

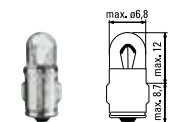

Fig. 5.



Fig. 6.

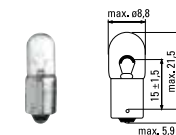
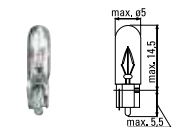

Fig. 7.



* PS - Plastic cap

Type	ECE	W			Fig.	SKU	EAN
------	-----	---	--	--	------	-----	-----

Wedge base lamps with and without plastic cap
Lampes "wedge base" avec ou sans culot plastique
Glassockellampen mit und ohne Steckfassung
Lámparas con casquillo de vidrio y lámparas con base de plástico
Lampade con attacco vetro e/o in plastica

5301 PS*		1,2	B8,5d	1/10/200	1	93438	0043168379885
				10/200	1	13264	0043168132640
91641 PS*		1,2	B8,4d	10/200	2	93673	0043168936736
91645 PS*		2	BX8,4d	10/200	3	93656	0043168936569
91646 PS* 14V		1,12	B8,4d	10/200	4	93657	0043168936576
504	W3W	3	W2,1x9,5d	1/10/200	5	41952	0043168379106
				10/200	5	27887	9004102238492
				2/20 blister	5	35452	0043168354523
501	W5W	5	W2,1x9,5d	1/10/200	6	41961	0043168379113
				10/200	6	27888	0043168924580
				2/20 blister	6	17138	0043168354530
501NB	W5W	5	W2,1x9,5d	10/200	7	97387	0043168936552
				2/20 blister	7	93011341	0064894508172
501NA	WY5W	5	W2,1x9,5d	10/200	8	21512	0043168924658
				2/20 blister	8	90199	0043168901994
W16W	W16W	16	W2,1x9,5d	10/200	9	21513	0043168215138
WY16WNAL	WY16W	16	W2,1x9,5d	10/200	10	93032367	0064894538834
				2/20 blister	10	93032366	0064894538827

* PS - Plastic cap

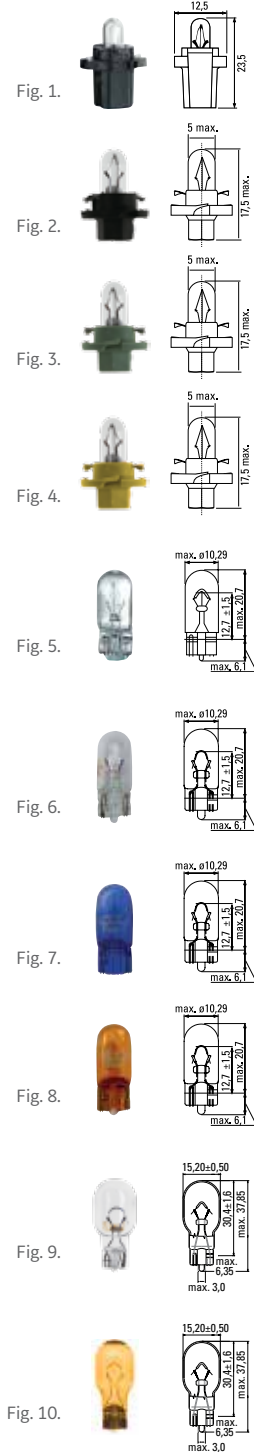

replacable with OEM lamps

Heavy Star



 **24V Truck lamps with longer life and increased robustness.**

 **Les lampes 24V pour les poids lourds avec une durée de vie allongée et une résistance accrue**

 **24V Lampen für LKW und Busse mit längerer Lebensdauer und höherer Robustheit**

 **Lámparas de camión de 24v, con una duración de vida más larga y una mayor solidez**

 **Lampade per Mezzi Pesanti: 24V, durata di vita e robustezza superiori alle lampade standard**



Type	ECE	W			Fig.	SKU	EAN
------	-----	---	--	--	------	-----	-----

Heavy Star - Halogen headlight lamps

Headlight lamps – upper and lower beam

Lampes principales

Hauptscheinwerferlampen

Lámparas de faro

Lampade per proiettori – abbagliante ed anabbagliante

50320/1U_HDL	H1	70	P14,5s	1/10/100	1	61493	0043168614931
50350U_HDL	H3	70	Pk22s	1/10/200	2	61496	0043168614962
50450HDLU	H4	75/70	P43t	1/10/100	3	61494	0043168614948
58521HDLU	H7	70	Px26d	1/10/100	4	61495	0043168614959

Heavy Star - Miniature lamps

Tail, direction, parking and indicator lamps

Feu rouge/clignotant/Feu de position/Répetiteur latéral

Blink-, Brems- und Schlußlichtlampen

Lámparas traseras, marcha atrás e indicadoras

Lampade per fanali posteriori, luci di arresto e direzione

1060HDL	P21W	21	BA15s	10/200	5	77095	0043168770958
				2/20 blister	5	99604	0043168996044
1061HDL	P21W	21	BA15d	10/200	6	77097	0043168770972
1073HDNAL	PY21W	21	BAU15s	10/200	7	77329	0043168773294
2627HDL	R5W	5	BA15s	10/200	8	77334	0043168773348
2643HDL	R10W	10	BA15s	10/200	9	77342	0043168773423
2661HDL	T4W	4	BA9S	10/200	10	61485	0043168614856
				2/20 blister	10	99605	0043168996051

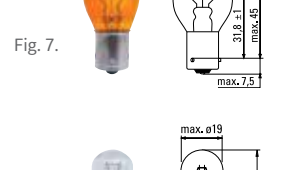
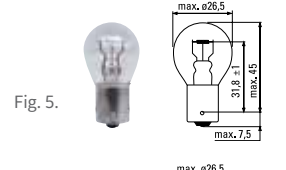
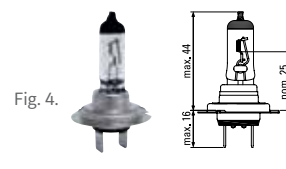
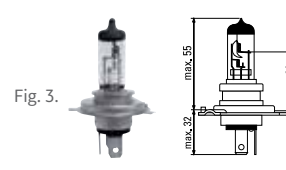
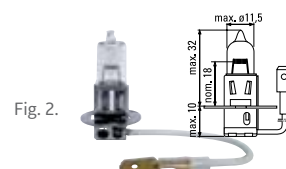
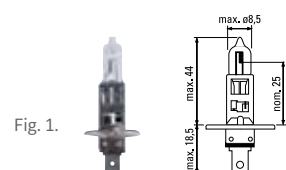

	Type	ECE	W			Fig.	SKU	EAN
Headlight lamps – upper and lower beam Lampes principales Hauptscheinwerferlampen Lámparas de faro Lampade per proiettori – abbagliante ed anabbagliante								
H1	50320/1U	H1	70	P14,5s	1/10/100	1	23793	9004102237938
							1/10 blister	1
H3	50350U	H3	70	Pk22s	1/10/200	2	21149	9004102211495
							1/10 blister	2
	50400U Rally*		100	Pk22s	1/10/200	2	38659	0043168386593
H4	50450U	H4	75/70	P43t	1/10/100	3	38836	9004102237402
							1/10 blister	3
	52080U	H4	75/70	P45t	1/10/100	3	43066	9004102237471
	52710U Rally*		100/70W	P43T	1/10/100	3	94938	0043168386647
H7	58521U	H7	70	Px26d	1/10/100	5	38838	0043168388382
							1/10 blister	5

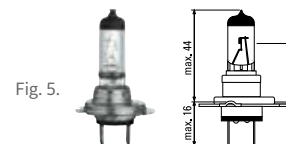
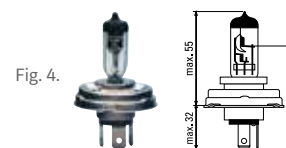
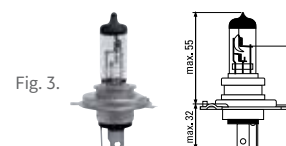
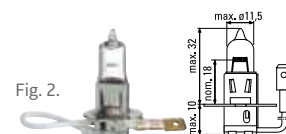
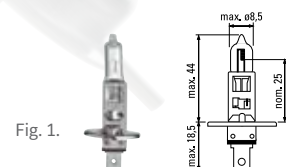

Rally* - OFF ROAD use only

Type	ECE	W			Fig.	SKU	EAN
------	-----	---	--	--	------	-----	-----

Tail, direction, parking and indicator lamps
 Feu rouge/clignotant/Feu de position/Répétiteur latéral
 Blink-, Brems- und Schlußlichtlampen
 Lámparas traseras, marcha atrás e indicadoras
 Lampade per fanali posteriori, luci di arresto e direzione

1060HD*	P21W	21	BA15s	1/10/200	1	37895	0043168378956
				10/200	1	17222	9004102348849
1061HD*	P21W	21	BA15d	10/200	2	17225	9004102349921
2626HD*	R5W	5	BA15d	10/200	3	17309	9004102349983
2627HD*	R5W	6	BA15s	1/10/200	4	37898	0043168378987
				10/200	4	17311	9004102349396
2643HD*	R10W	10	BA15s	1/10/200	5	37958	0043168379588
				10/200	5	17313	9004102349402
2661HD*	T4W	4	Ba9s	10/200	6	27341	9004102349334

* Supported Heavy Duty (HD) lamps
 Lampes renforcées (anti vibration)
 Heavy-Duty-Lampen
 Lámparas reforzadas HD
 Lampade rinforzate HD

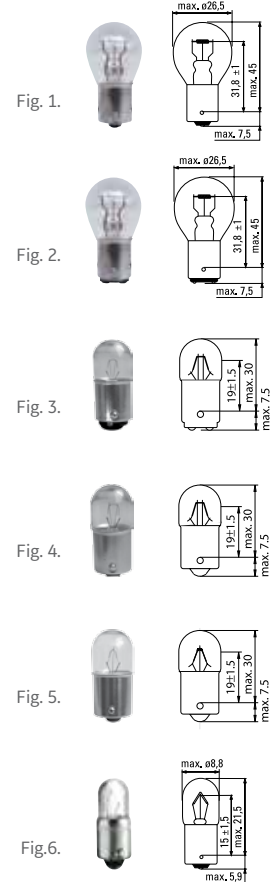

Type	ECE	W			Fig.	SKU	EAN
Tail, direction, parking and indicator lamps Feu rouge/clignotant/Feu de position/Répétiteur latéral Blink-, Brems- und Schlußlichtlampen Lámparas traseras, marcha atrás e indicadoras Lampade per fanali posteriori, luci di arresto e direzione							
2626	R5W	5	BA15d	10/200	1	17308	9004102349990
2627	R5W	5	BA15s	10/200	2	17310	9004102238294
2643	R10W	10	BA15s	10/200	3	17312	9004102238355
2692	DIN 72601J	3	BA7s	10/200	4	27380	9004102349259
2661	T4W	4	BA9s	10/200	5	27327	9004102238393
2663		2	BA9s	10/200	6	27355	9004102349341
91602		1,2	W2x4,6d	10/200	7	65718	0043168132565
				1/10/200	7	65717	0043168379816
5302PS*		1,2	B8,5d	1/10/200	8	93442	0043168387774
				10/200	8	13269	0043168132695
91693		1,2	EBS R11	10/200	9	93662	0043168936620
5305	W3W	3	W2,1x9,5d	1/10/200	10	97226	0043168387767
				10/200	10	65830	0043168132619
91622	W5W	5	W2,1x9,5d	10/200	10	65680	0043168936545

* PS - Plastic cap

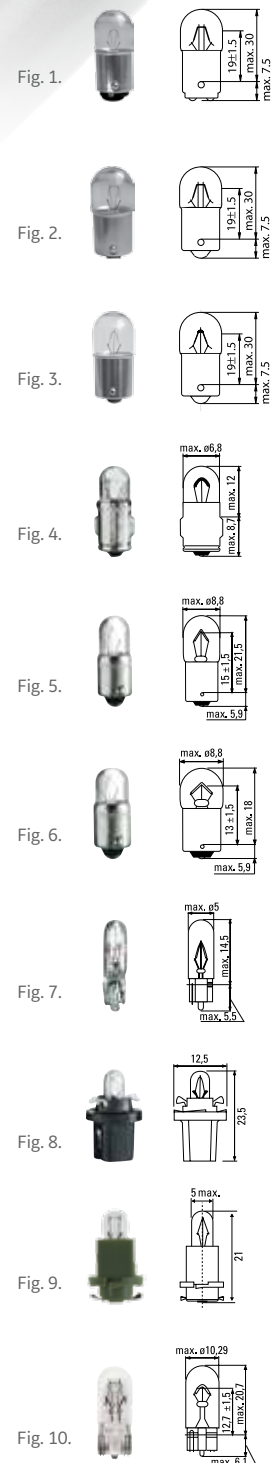

Type	ECE	W			Fig.	SKU	EAN
------	-----	---	--	--	------	-----	-----

Interior lamps
Lampes éclairage interieur
Lampen für Innenbeleuchtung
Lámparas de interior
Lampade per illuminazione interna

7552	C5W	5	SV8,5-8	10/200	1	27773	9004102238454
91716		10	SV8,5-8	10/200	1	73601	0043168936699
7579		5	SV8,5-8	10/200	2	27788	0043168388061
7580		10	SV8,5-8	10/200	2	27795	9004102349419
7594		15	SV8,5-8	10/200	3	27802	0043168388078
7595	DIN 72601K	18	SV8,5-8	10/200	3	27806	0043168388092

Tail, stop and direction lamps
Feu rouge/Stop/Clignotant
Rücklicht-, Brems- und Schlußlichtlampen
Lámparas traseras, freno e intermitente
Lampade pe fanali posteriori, luci di arresto e direzione

1115		15	BA15s	10/200	4	17238	0043168387422
1117	DIN 72601R	18	BA15s	10/200	4	17240	0043168387446
1060	P21W	21	BA15s	10/200	5	17221	9004102238072
1061	P21W	21	BA15d	10/200	6	17223	9004102349938
1073	PY21W	21	BAU15s	10/200	7	17250	9004102344520
1078	P21/5W	21/5	BAY15d	1/10/200	8	38731	0043168387316
				10/200	8	17232	9004102238133
				2/20 blister	8	38727	0043168387279
54400	H21W	21	BAY9S	10/200	9	94715	0043168947152

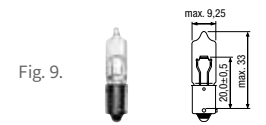
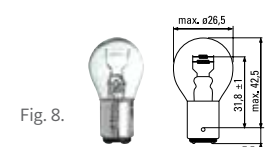
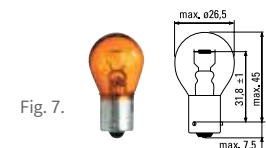
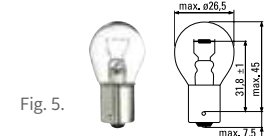
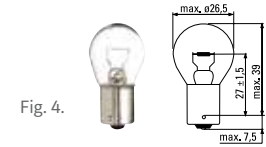

replacable with OEM lamps

Lamp kits

Premium “QUAD kits”

CONTENT		SKU	EAN
2XH4 Megalight Ultra +90 + 2X 501NB W5W	1/10	99627	0043168996273
2XH7 Megalight Ultra +90 + 2X 501NB W5W	1/10	99628	0043168996280
2XH1 Megalight Ultra +90 + 2X 501NB W5W	1/10	99629	0043168996297
2XH4 Sportlight+50 + 2X 501NB W5W	1/10	99666	0043168996662
2XH7 Sportlight+50 + 2X 501NB W5W	1/10	99667	0043168996679
2XH1 Sportlight+50 + 2X 501NB W5W	1/10	99668	0043168996686



Emergency Kits

Coffrets de Secours

Ersatzdose

Estuche de repuesto

Scatola lampade di scorta

CONTENT		SKU	EAN
H4, PY21W, P21/5W, P21W, R5W, C5W, W5W, T4W, normal fuses 10A, 15A, 20A, mini fuses 7,5A, 10A, 20A	1/10	70693	0043168706933
H1, PY21W, P21/5W, P21W, R5W, C5W, W5W, T4W, normal fuses 10A, 15A, 20A, mini fuses 7,5A, 10A, 20A	1/10	70706	0043168707060
H7, PY21W, P21/5W, P21W, R5W, C5W, W5W, T4W, normal fuses 10A, 15A, 20A, mini fuses 7,5A, 10A, 20A	1/10	70694	0043168706940
H1+H7, PY21W, P21/5W, P21W, R5W, C5W, W5W, T4W, normal fuses 10A, 15A, 20A, mini fuses 7,5A, 10A, 20A	1/10	70707	0043168707077
24V H1+H7, PY21W, P21/5W, P21W, R5W, C5W, W5W, T4W, normal fuses 10A, 15A, 20A, mini fuses 7,5A, 10A, 20A	1/10	96754	0043168967549
H1, P21/5W, P21W, R5W, C5W, fuses 10A, 15A, 20A	1/10	92751	0043168927512
H4, P21/5W, P21W, R5W, C5W, fuses 10A, 15A, 20A	1/10	92752	0043168927529
H7, P21/5W, P21W, R5W, C5W, fuses 10A, 15A, 20A	1/10	92753	0043168927536
H1+H7, P21/5W, P21W, R5W, C5W, fuses 10A, 15A, 20A	1/10	92755	0043168927550



Displays

GE wall displays Vacuum formed plastic body and positions for boxes, foam insert for miniature lamps

Defined content for 161 lamps - main halogens and miniatures. Shipped as empty (sku 88653) or filled (sku 82881).



Defined content for 121 lamps - main halogens and miniatures. Shipped as empty (sku 98416).



GE wall cupboards Vacuum formed plastic body, including lamp tester



Defined content for 591 lamps - main halogens and miniatures. Shipped as empty (sku 64983) or filled (sku 65234).



Defined content for 680 lamps main halogens and miniatures. Shipped as empty (sku 98417).

GE wall or counter display

Type	Code
Empty display	75040
Sportlight	75041
Megalight Ultra	75042



GE auto aftermarket pack concept

GE Lighting – has been a leading supplier to Automotive OEM and Aftermarket customers throughout the world for many decades. We continue our pioneering work to offer advanced solutions and benefits that can fulfill our customers' needs.

Our brand is the symbol of our heritage, and of the quality and trust we have delivered to our customers. It embodies our commitment to anticipate and meet their changing needs. It represents the imagination we use to address those needs in a manner that reflects our values.

As a result of continuous efforts to fulfill our customers' changing needs - GE has developed the aftermarket packaging concept. The main objective of our redesigned packaging is to enhance the shopping experience and drive upsell.

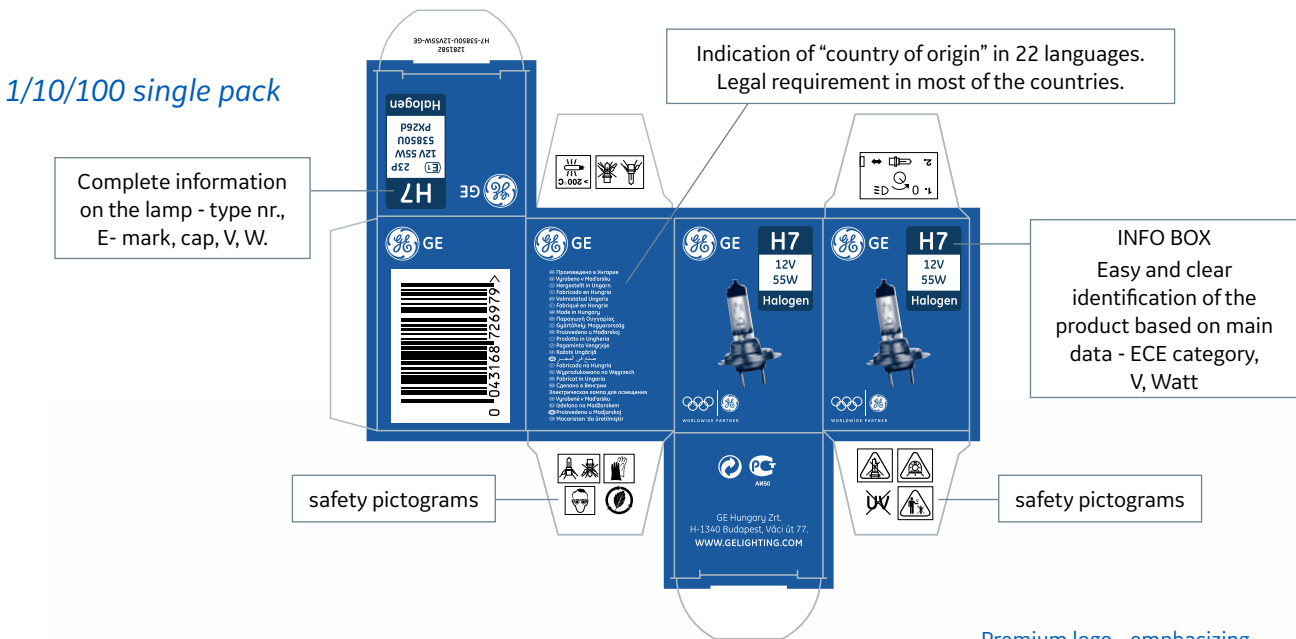

GE twinbox/display pack



Translation of the premium feature/ benefit explanation in 11 languages.

GE 10-way pack



GE Blister

Our redesigned blister pack has the following advantages:

GLOBAL: packages reflect a “world view”, display the elements of environmental and regulatory requirements, use multiple languages

TRUSTED: make the purchase easier and clearer, simplified messaging that is repeated on all platforms

PRECISE: package information is clear and states features prominently

APPROACHABLE, SIMPLE: Easy to understand and right for the purchaser, helping them to decide which product is good for them. Provides differentiation between standard range and premium ranges by using color coding.

Info circle with simplified nr. that allows quick search/identification in the GE lampguide. Clear and simple information on the specific product

description of the lamp function in 10 languages

country of origin in 22 languages

safety pictograms

original equipment logo + translation in 8 languages, emphasizing GE OEM presence

lamp drawing with E-mark

Colour coded packages tied directly to POS messaging for easy identification:

STANDARD range - describe the standard categories, D2 discharge, 12V-24V halogen and miniature lamps

PREMIUM range with feature/benefit logo, explain how one product differs from another, and why it is most appropriate for its task - rationalize the move to upsell in the halogen and miniature lamp categories

Standard ranges

- D2 gas discharge lamps
- 12V halogen and miniature lamps
- 24V halogen and miniature lamps











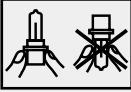

Premium ranges

- Megalight ultra +150
- Megalight ultra +130
- Megalight ultra +120
- Megalight ultra +90
- Megalight plus 50
- Spotlight
- Spotlight Extreme
- Spotlight Ultra
- Extra life
- Heavy Star
- Rally
- Motorcycle

GE Blister range

Product Code	Type	Designation	Simplified number	Lamp in blister	Wattage	Volt	EAN code
17119	50310U	H1	04	1	55W	12V	0043168354301
19758	50310MPU	H1 Megalight Plus 50	04MPU	2	55W	12V	0043168197588
96948	50310XU	H1 Megalight Ultra - Plus 90	04XU	2	55W	12V	0043168969482
98266	50310NU	H1 Megalight Ultra - Plus 120	04NU	2	55W	12V	0043168982665
19685	50310LU_DPU	H1 Extra Life	04DPU	2	55W	12V	0043168196857
73343	50310NHSU	H1 Sportlight	04NHSU	2	55W	12V	0043168908344
93012845	50310SBU	H1 Sportlight Ultra	04SBU	2	55W	12V	0064894521805
35434	52140U	H1 Rally - offroad	104	1	100W	12V	0043168354349
38679	50320U	H1	74	1	70W	24V	0043168386791
17117	50340U	H3	05	1	55W	12V	0043168354325
37963	52130U	H3 Rally - offroad	105	1	100W	12V	0043168379632
38674	50350U	H3	75	1	70W	24V	0043168386746
17123	58520U	H7	03	1	55W	12V	0043166354356
97131	58320NHSU	H7 Sportlight	03NHSU	2	55W	12V	0043168887892
93012861	58520SBU	H7 Sportlight Ultra	03SBU	2	55W	12V	0064894521904
19759	58520MPU	H7 Megalight Plus 50	03MPU	2	55W	12V	0043168197595
74154	58520SXU	H7 Megalight Ultra - Plus 90	03SXU	2	55W	12V	0043168741545
98282	58520SNU	H7 Megalight Ultra - Plus 120	03SNU	2	55W	12V	0043168982825
19686	58520LU_DPU	H7 Extra Life	03DPU	2	55W	12V	0003168196864
45691	58521U	H7 24V	77	1	70W	24V	0043168456913
17120	50440U	H4	01	1	60/55W	12V	0043168354417
35930	50440U	H4	01	2	60/55W	12V	0043168359306
91579	50450U	H4	71	1	60/55W	24V	0043168915793
93361	50440MPU	H4 Megalight Plus 60	01MPU	2	60/55W	12V	0043168933612
74153	50440SXU	H4 Megalight Ultra - Plus 90	01SXU	2	60/55W	12V	0043168741538
98281	50440SNU	H4 Megalight Ultra - Plus 120	01SNU	2	60/55W	12V	0043168982818
19682	50440LU_DPU	H4 Extra Life	01DPU	2	60/55W	12V	0043168196826
97132	53800NHSU	H4 Sportlight	01NHSU	2	60/55W	12V	0043168887908
93012846	50440SBU	H4 Sportlight Ultra	01SBU	2	60/55W	12V	0064894521812
18266	53060U	HB3	07	1	60W	12V	0043168182669
18267	53070U	HB4	09	1	51W	12V	0043168182676
18254	53090U	H8	13	1	35W	12V	0043168182546
18256	53100U	H9	15	1	65W	12V	0043168182560
60957	53110U	H11	16	1	55W	12V	0043168609579
17131	1057	P21W	21	2	21W	12V	0043168354066
23284	1057LFD	P21W Extra Life	21D	2	21W	12V	0043168232845
99604	1060HDL	P21W Heavy Star	81HDL	2	21W	24V	0043168996044
17130	1077	P21/5W	23	2	21/5W	12V	0043168354097
23285	1077LFD	P21/5W Extra Life	23D	2	21/5W	12V	0043168232852
38727	1078	P21/5W	93	2	21/5W	24V	0043168387279
38728	1098	20/5W	48	2	20/5W	12V	0043168387286
35931	1122	P21/4W	20	2	21/4W	12V	0043168359313
37969	1157	1157 ANSI	39	2	32/3W	12V	0043168379694
17133	1056	PY21W	22	2	21W	12V	0043168354073
17136	2619	R5W	24	2	5W	12V	0043168353984
23286	2619LFD	R5W Extra Life	24D	2	5W	12V	0043168232869
17137	2662	T4W	26	2	4W	12V	0043168354509
23292	2662LFD	T4W Extra Life	26D	2	4W	12V	0043168232920
17134	2641	R10W	30	2	10W	12V	0043168354059
37960	2660	2660	38	2	2W	12V	0043168379601
38855	2696	72601J	47	2	2W	12V	0043168388559
35451	5301	W1,2W	29	2	1,2W	12V	0043168354516
35452	5304	W3W	27	2	3W	12V	0043168354523
17138	501	W5W	28	2	5W	12V	0043168354530
90199	501A	WY5W	33	2	5W	12V	0043168901994
93011341	501NB	W5W	28	2	5W	12V	0064894508172
17129	7546	C5W	25	2	5W	12V	0043168354608
23308	7546LFD	C5W Extra Life	25D	2	5W	12V	0043168233088
37956	7575	7575	40	2	5W	12V	0043168379564
35463	7576	DIN 72601K	31	2	10W	12V	0043168354639
39459	7585	7585	32	2	10W	12V	0043168394598
38803	7592	72601K	42	2	15W	12V	0043168388030
38850	52830	H6W	62	1	6W	12V	0043168388504
93447	7440	W21W	50	2	21W	12V	0043168934473
512863	7443	W21/5W	49	2	21/5W	12V	5994101128631
76091	7440NA	WY21W	51	2	21W	12V	0043168760911
93032366	WY16W	WY16WNAL	52	2	16W	12V	0064894538827

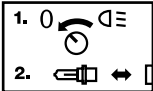
Symbols used on the packaging

						
Do not touch with bare fingers	No disposal of as household waste	For removal and installation use appropriate eye protection	Dangerous voltage	Installation and servicing of electronic device only by qualified electrical employees	For removal and installation use appropriate gloves	Read attached instructions before use
						
Operation only in luminaire installations with protective shield	Don't let children play with bulbs	No operation of lamps with scratched or damaged glass bulb	Beware of temperature	Switch off light before re-lamping	Not suitable for household use	Use as vehicle lamp 12V or 24V

Base stamps on the GE automotive lamps

Halogen auto lamp marking

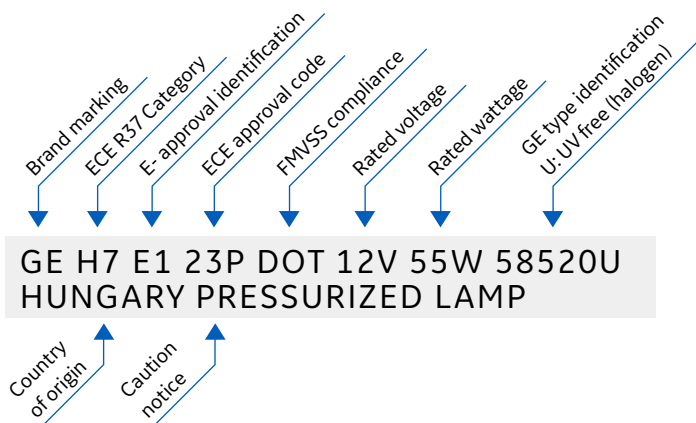

Miniature auto lamp marking

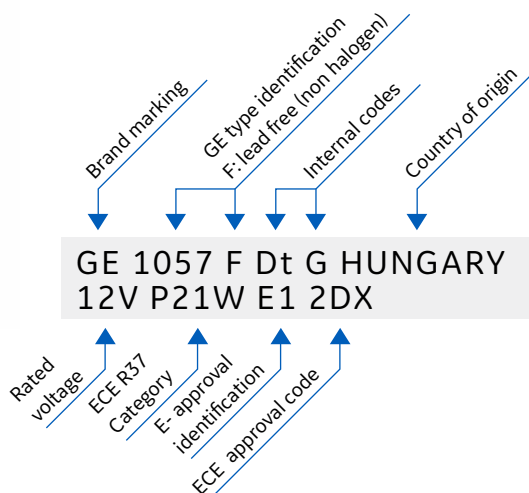

Lamp bases

Culot – Sockelübersicht – Casquillos de lámparas – Attacchi lampade

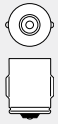

BA7s

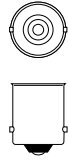

BA9s



BA15s



BAU15s



BA15d

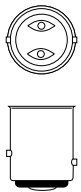

BAY15d



BAZ15d

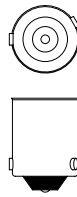

BAX9s



P14,5s/R



P14,5s

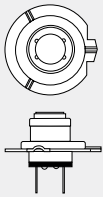

PX26d



E10

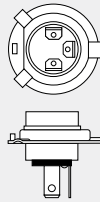

P43t



P45t

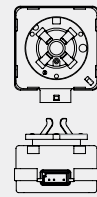

PK32d-2

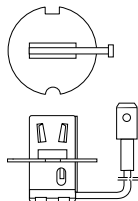

PK22s

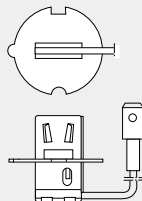

PK22s/R



SV8,5



P32d-2

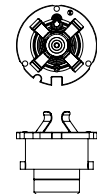

P32d-3

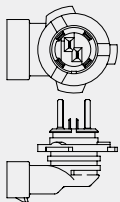

PY20d

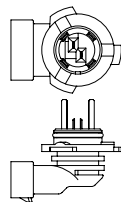

P20d

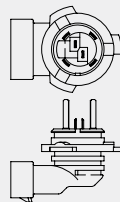

P22d



W2,1x9,5d



W2x4,6d

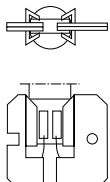

X511

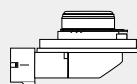

PGJ19

Original supplier of the world's
main car manufacturers.



www.automotive.tungsr.com

Imagination at work

GE Lighting is constantly developing and improving its products. For this reason, all product descriptions in this catalogue are intended as a general guide, and we may change specifications from time to time in the interest of product development, without prior notification or public announcement. All descriptions in this publication present only general particulars of the goods to which they refer and shall not form part of any contract. Data in this guide has been obtained in controlled experimental conditions. However, GE Lighting cannot accept any liability arising from the reliance on such data to the extent permitted by law.

All lamp drawings are a guide, if further technical details are required please contact your nearest sales office.

General conditions of sale

GE Lighting products are supplied according to GE's General Conditions of Sale. If you require a copy of these conditions please contact your nearest GE Lighting sales office.

Prices

A price list is available from all GE Lighting sales offices.

GE and General Electric are both registered trademarks of the General Electric Company

08/2018

